

INSTALLATION MANUAL

LCI-100 Line Control Instrument Dual Tension Input Model

Revision 1.01.B
August 30, 2001

LCI-100

LINE CONTROL INSTRUMENT

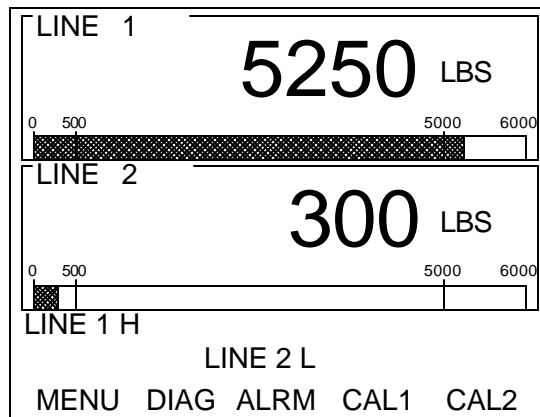

MEASUREMENT TECHNOLOGY NW
www.mtnw-usa.com



Copyright 2001
Measurement Technology NW
4211 – 24th Ave West
Seattle WA 98199, USA

Phone: 206.634.1308
Fax: 206.634.1309
Email: LCI@mtnw-usa.com

Table of Contents

1.0	Overview	6
2.0	Quick Start	7
2.1	Mounting	7
2.2	Basic Field Wiring	7
2.3	Basic Hardware Configuration	8
2.4	Basic Operation	8
3.0	Mechanical Installation	11
3.1	Environmental Considerations	11
3.2	Dimensions and Cutout	11
3.3	Display Mounting	11
4.0	Options and Wiring Diagrams	12
4.1	Wiring Hookup – Local Display	13
4.1.1	Display power and fuse.....	13
4.1.2	Tension Sensor Inputs	13
4.1.3	Alarm Outputs	18
4.1.4	Shunt Calibration.....	18
4.1.5	Analog Outputs.....	19
4.1.6	Serial Communications	20
4.2	Wiring Hookup – LCI-90R Remote Display	21
4.2.1	LCI-90R display power and fuse.....	21
4.2.2	LCI-90R communication ports	22
4.2.3	LCI-90R display brightness adjustment.....	23
5.0	Local Display Operation	24
5.1	Front Panel Identification	24
5.2	Programming Menu	24
5.3	Alarms	26
5.3.1	Acknowledging alarms	27
5.3.2	Setting alarm limits	27
5.3.3	Configuring Alarms	28
5.4	Tension Calibration Line 1	29
5.4.1	Scale and offset – Line 1.....	29
5.4.2	Two point live calibration – Line 1.....	30
5.5	Tension Calibration Line 2	31
5.5.1	Scale and offset – Line 2.....	31
5.5.2	Two point live calibration – Line 2.....	32
5.6	Tension Tare – Line 1	33
5.6.1	Tension Tare – Line 1	33
5.7	Tension Tare – Line 2	33
5.7.1	Tension Tare – Line 2	34
5.8	Shunt Calibration – Line 1	34
5.8.1	Shunt Calibration – Line 1	34
5.9	Shunt Calibration – Line 2	34

5.9.1	Shunt Calibration – Line 1.....	35
5.10	Wrap Angle – Line 1.....	35
5.10.1	Wrap angle adjustments – Line 1.....	35
5.11	Wrap Angle – Line 2.....	36
5.11.1	Wrap angle adjustments – Line 2.....	36
5.12	Display Configuration.....	36
5.12.1	Setting display units – Line 1.....	37
5.12.2	Setting decimal places – Line 1.....	37
5.12.3	Setting Bar Graph Range – Line 1.....	37
5.12.4	Tension Display Smoothing – Line 1.....	38
5.12.5	Setting display units – Line 2.....	38
5.12.6	Setting decimal places – Line 2.....	39
5.12.7	Setting Bar Graph Range – Line 2.....	39
5.12.8	Tension Display Smoothing – Line 2.....	39
5.12.9	Screen saver.....	39
6.0	Hardware Configuration.....	40
6.1	Security.....	40
6.2	Factory Setup.....	40
6.3	Analog Input Configuration.....	40
6.3.1	Sensor Input Check Alarm.....	41
6.4	Analog Output Channels.....	41
6.4.1	Calibrating the analog output signal.....	42
6.5	Alarm Configuration.....	42
6.5.1	Alarm types.....	43
6.5.2	Alarm limits.....	43
6.5.3	Alarm outputs.....	43
6.6	Serial Communication.....	44
6.6.1	Local/Remote operation modes.....	45
6.6.2	Programming remote displays.....	45
6.6.3	AUX com port settings.....	45
6.6.4	Protocol descriptions.....	46
6.6.5	Polling Strings.....	47
7.0	Remote Display Operation.....	48
7.1	Active Remotes – REM-A.....	48
7.2	Blind Remotes – REM-B.....	48
8.0	Troubleshooting.....	50
8.1	DIAG screen operation.....	50
8.2	Troubleshooting procedures.....	50
8.3	Technical support.....	54
9.0	Appendix A – Dimensional Drawing.....	55
10.0	Appendix B – Jumper Settings on Interface PCB – REV 1.....	56
11.0	Appendix C – Analog Hardware Configuration.....	58
12.0	Appendix D – Interface PCB REV 1.....	60
13.0	Appendix E – Wrap Angle Calculations.....	61
14.0	Appendix F – LCI-100 Specifications.....	62

15.0 Appendix G – LCI-90R Specifications..... 64

Figures and Tables

Figure 1.1 – LCI-100 Front Panel.....	6
Figure 2.1 – Power Hookup – DC Power	7
Figure 2.2 – Tension 1 Hookup – 4 Wire 4-20 mA Signal.....	8
Figure 2.3 – Tension 2 Hookup – 4 Wire 4-20 mA Signal.....	8
Figure 4.1 – Identification of hardware options and manual sections by function.....	12
Figure 4.2 – Fuse rating and replacement part – Local display	13
Figure 4.3 – Local Display Power Hookup – DC Power.....	13
Figure 4.4 – Local Display Power Hookup – AC Power.....	13
Figure 4.5 – Tension 1 Hookup – 3 Wire 4-20 mA Signal.....	14
Figure 4.6 – Tension 2 Hookup – 3 Wire 4-20 mA Signal.....	14
Figure 4.7 – Tension 1 Hookup – 4 Wire 4-20 mA Signal.....	15
Figure 4.8 – Tension 2 Hookup – 4 Wire 4-20 mA Signal.....	15
Figure 4.9 – Tension 1 Hookup – 2 Wire 4-20 mA Signal.....	15
Figure 4.10 – Tension 2 Hookup – 2 Wire 4-20 mA Signal.....	16
Figure 4.11 – Tension 1 Hookup – 4 Wire DC Voltage Input.....	16
Figure 4.12 – Tension 2 Hookup – 4 Wire DC Voltage Input.....	16
Figure 4.13 – Tension 1 Hookup – 4 Wire Strain Gauge	17
Figure 4.14 – Tension 2 Hookup – 4 Wire Strain Gauge	17
Figure 4.15 – Tension 1 Hookup – Isolated 2 Wire 4-20 mA Signal	17
Figure 4.16 – Tension 2 Hookup – Isolated 2 Wire 4-20 mA Signal	18
Figure 4.17 – Alarm Output Hookup – 8 Channels	18
Figure 4.18 – Shunt Calibration Hookup	19
Figure 4.19 – Non-isolated Analog Output Hookup	19
Figure 4.20 – Non-isolated Analog Output Hookup	19
Figure 4.21 – Isolated Analog Output Hookup – 4 Channels	20
Figure 4.22 – RS-485 Network Communication Hookup	20
Figure 4.23 – Remote Display Fuse rating and replacement part	21
Figure 4.24 – Remote Display Power Hookup – DC Power	21
Figure 4.25 – Remote Display Power Hookup – AC Power	21
Figure 4.26 – LCI-90R Auxiliary RS-232 Hookup	22
Figure 4.27 – LCI-90R Network RS-232 Hookup	22
Figure 4.28 – LCI-90R Network RS485 Hookup	22
Figure 5.2 – LCI 100 Menu Tree	26
Figure 5.3 – Sample Alarm Message Display	27
Figure 5.4 – Digital Output Module Locations and Menu Names, 4 of 8 Channels Shown ..	28
Figure 5.5 – LCI-100 Display Units	37
Figure 5.6 – LCI-100 Display Units	38
Figure 6.1 – Analog Output Module Locations and Menu Names	42
Figure 8.1 – Diagnostics Screen Display.....	50

1.0 Overview

The LCI-100 Line Control Instrument is a versatile instrument that displays two channels of line Tension for winch and wire rope applications, Line 1 and Line 2. Signals from Tension sensors are converted into engineering units and displayed on a high visibility electro-luminescent display. The display and the five front panel keys underneath it allow the operator to acknowledge alarms and to manipulate the calibration and configuration menus. The function of each key is indicated by the label that appears immediately above it in the Display. As the operator navigates through various displays the functions of these keys and their associated labels will change. The LCI-100 can be user configured to accept inputs from a range of Tension sensors, display the parameters in different units and resolutions, enable as many as six different alarms, and select a variety of serial communication options.

This manual is intended to cover the installation, set-up, and operation of the LCI-100 and the LCI-90R remote display.

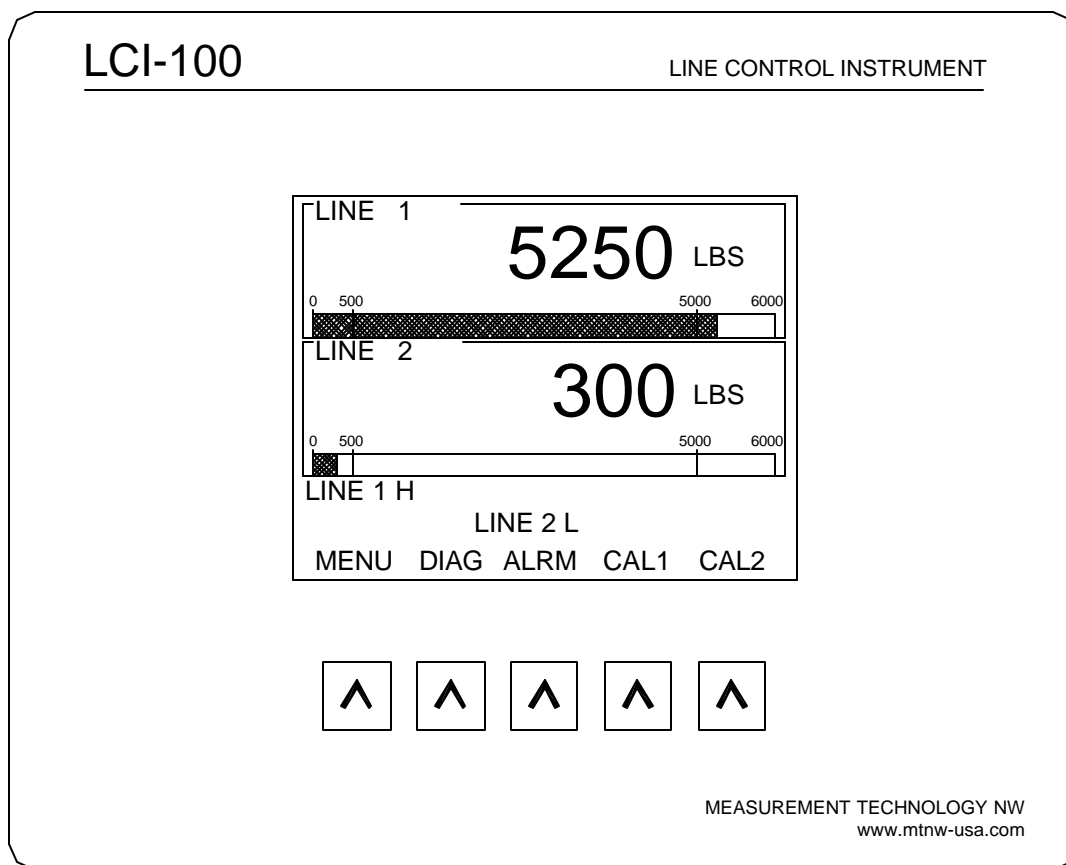

Figure 1.1 – LCI-100 Front Panel

2.0 Quick Start

This section provides a subset of the full technical manual to facilitate installation and start-up of the LCI-100. For a complete technical description please refer to Sections 3.0-6.0.

2.1 Mounting

The LCI-100 will fit in a 9.25 x 7.00” cutout, with a minimum of 5.5” depth clearance (see Appendix A for dimensional drawing). The instrument is held in place with removable panel clamps that screw to all sides of the display. Four clamps are included with each display.

After sliding the display into the cutout, screw the four panel clamps on the sides of the display, with the flanged end of the clamp toward the panel, using two 10-32 machine screws per bracket. Once the panel clamps are installed, tighten the jackscrews against the panel to compress the LCI-100 gasket to seal against the panel. Lock the jackscrews with hex nuts to prevent them from vibrating loose over time.

2.2 Basic Field Wiring

Basic field wiring connections for the LCI-100 are those required for power, and for the force transducers. The base unit LCI-100 (i.e. no options) is shipped with hardware settings to accommodate the following field devices: two 4-20 mA Tension sensors. The LCI-100 can be connected to a broad range of field sensors; wiring connections for these are explained in detail in Section 4.0.

DC power (and serial communications) connections are made to the printed circuit board directly behind the display. Tension inputs, alarm wiring and analog outputs go to quick-connect style terminal blocks on the “interface PCB”. These blocks are referenced by both a label indicating the function (‘analog’, ‘digital’), and by an ID number (‘TB2’) on the top of the block. The field interconnects described below are different if the stainless steel rear enclosure option is selected. Consult the factory for wiring information.

The connection diagrams for the factory standard power input, Tension sensors are shown in the tables below. The LCI-100 terminal blocks are listed on the left by function and number, and the field devices are listed on the right.

DC Power Connection

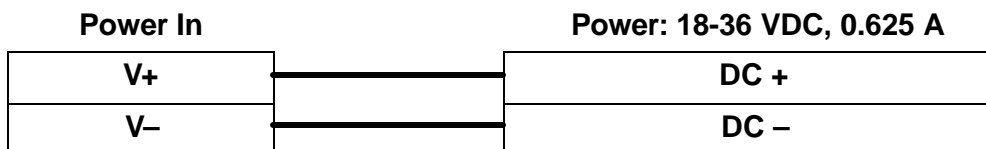

Figure 2.1 – Power Hookup – DC Power

Direct Input – 4-20 mA, Four Wire, Channel 1

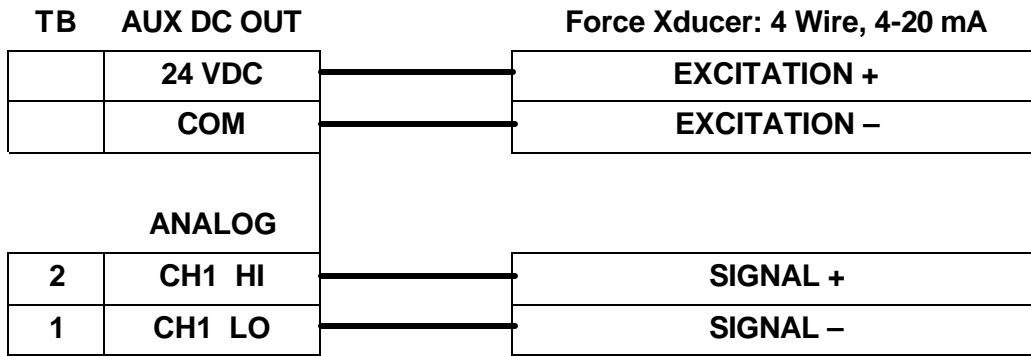

Figure 2.2 – Tension 1 Hookup – 4 Wire 4-20 mA Signal

Direct Input – 4-20 mA, Four Wire, Channel 2

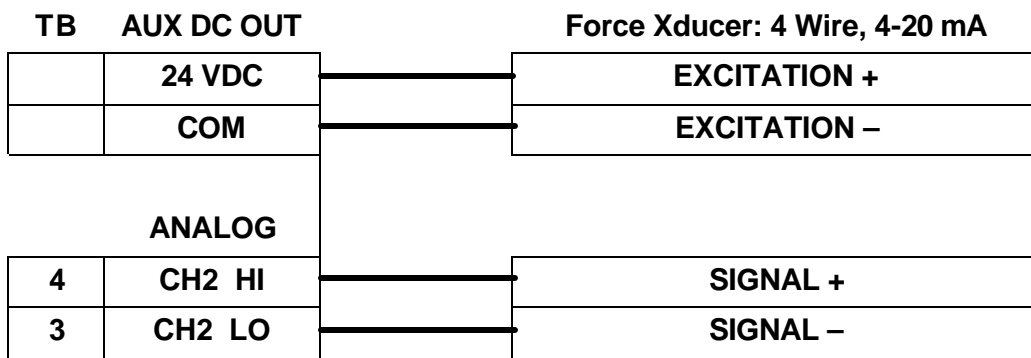

Figure 2.3 – Tension 2 Hookup – 4 Wire 4-20 mA Signal

2.3 Basic Hardware Configuration

The base unit LCI-100 (i.e. no options) will accommodate the field device wiring and input devices shown in Section 2.2 above. The base unit has an open frame black anodized aluminum housing. No menu programming or hardware jumper changes are necessary if these inputs are used. Setup procedures for alarms, analog outputs, input isolation modules, and serial communication options are discussed in Sections 4.0-6.0.

2.4 Basic Operation

The LCI-100 base unit is configured at the factory to display Channel 1 Tension (Line 1) at the top of the screen, Channel 2 Tension (Line 2) on the bottom and each with both a numeric parameter display and as an analog bar graph immediately underneath. The factory setting for units is pounds with 0 decimal places. Section 5.0 explains how to change these settings.

The calibration values for each Tension sensor must be set for each field application. The following is a description of the simplest calibration for the anticipated sensors described above. For complete instructions on the menu functions and calibration features refer to Section 5.0.

3.0 Mechanical Installation

The LCI-100 is designed for mounting on the front-panel of an electrical enclosure with a suitable environmental rating. The sealed front face of the LCI-100 is made of 12 gauge stainless steel, and the slotted rear cage is designed to promote heat transfer, facilitate field wire terminations, and provide a purchase point for the panel clamps. The front face is 8.0" high x 10.0" wide; the total depth is 5.5".

3.1 Environmental Considerations

The front face of the LCI-100 is designed for NEMA 4X applications. It consists of a 316 stainless steel top layer, a sealed lexan window, and five membrane-sealed stainless steel push buttons. The rear cage is NEMA 1 and requires protection with a suitable enclosure. A polyurethane gasket, held in-place by a high temperature adhesive is applied to the backside of the front face. When mounting the LCI-100 in open deck locations, a front-panel cover is recommended to protect the unit when it is not in use.

The standard temperature range of the LCI-100 is -20°C to $+60^{\circ}\text{C}$. The high temperature (HT) model will operate in temperatures from -40°C to $+70^{\circ}\text{C}$.

An optional rear enclosure built to provide a watertight housing is available to provide additional protection for the instrument. This rear enclosure can be mounted with an adjustable gimbal bracket. Consult factory for mounting information and temperature ratings.

3.2 Dimensions and Cutout

The LCI-100 will fit in a 9.25" x 7.00" cutout (tolerance -0.01 , $+0.100$), with a minimum of 5.5" depth clearance (see Appendix A for dimensional drawing). The front panel can be up to 5/8" thick.

3.3 Display Mounting

The instrument is held in place with removable panel clamps that screw to the 10-32 threaded inserts on all sides of the display. Four clamps are included with each display, but the unit can be installed using as few as two if a panel seal is not required.

Two hole patterns are available on each bracket. The bracket that is used on the bottom edge of the unit will need to use the holes that are located closer to the bend of the bracket. The remaining three brackets use the two holes located farthest from the bend.

After sliding the display into the cutout, screw the four panel clamps onto the sides of the display, with the flanged end of the clamp facing toward the panel. Once the panel clamps are installed, tighten the jackscrews against the panel to compress the LCI-100 gasket to seal against the panel. Lock the jackscrews with hex nuts to prevent them from vibrating loose over time.

4.0 Options and Wiring Diagrams

The LCI-100 can be configured for a wide range of signal input and output functions. Each of these functions requires the instrument to have the correct menu settings (Section 5.0), hardware jumper settings (Appendix C), signal and power wiring, and in some cases, optional I/O modules installed. The wiring diagrams are given in this Section; the optional I/O modules are listed in Appendix D. The table below gives of a summary of the LCI-100 functions, referenced to their associated menu, required hardware options, and section of this manual covering the wiring termination.

Function	Menu Number	Std/Option #	Wiring – Manual Section
DC Power	N/A	Std	4.1.1
Analog Input Direct 4-20 mA	4.2	Std	4.1.2
Analog Input Direct DC Voltage	4.2	Std	4.1.2
Analog Input Isolated	4.2	21,22,23	4.1.2
Alarm Output	4.4	01,02,03,04	4.1.4
Analog Output Direct 4-20 mA	4.3	30	4.1.5
Analog Output Direct DC Voltage	4.3	31	4.1.5
Analog Output Isolated	4.2	32, 33	4.1.5
Serial Comm. RS232, Network	4.5	10	4.1.6
Serial Comm. RS485, Network	4.5	11, 12	4.1.6
Serial Comm. RS232, Auxiliary	4.5	10	4.1.6

Figure 4.1 – Identification of hardware options and manual sections by function

4.1 Wiring Hookup – Local Display

This section provides wiring diagrams and related specifications for power and signal input and output connections for the LCI-100.

4.1.1 Display power and fuse

The fuse, F1, is located on the rear panel of the display. Use a flat blade screwdriver to open the cover for access. The replacement part is a 5 x 20 mm fuse rated according to the system options. See the table below for fuse sizing.

Model No	Fuse Rating	Littlefuse Part No
LCI-100-DC	5/8 A	216.630
LCI-100-AC	1/2 A	216.500

Figure 4.2 – Fuse rating and replacement part – Local display

The LCI-100-DC requires an 18-36 Volt DC power source. The connection for the power is shown below.

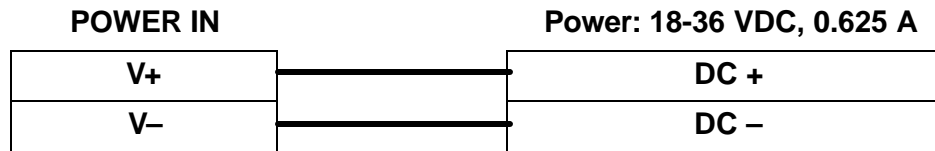

Figure 4.3 – Local Display Power Hookup – DC Power

The LCI-100-AC requires an 85-265 Volt AC power source. The connection for the power is shown below.

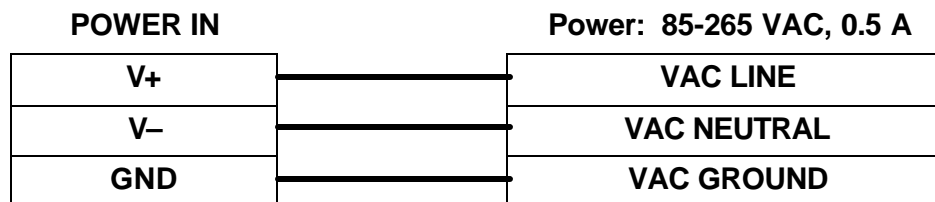

Figure 4.4 – Local Display Power Hookup – AC Power

4.1.2 Tension Sensor Inputs

The Tension sensor analog inputs both isolated and non-isolated are terminated on the bank of terminal blocks labeled Analog. These units are configured for just two analog inputs. The upper tension display responds only to the terminal block wiring for channel 1 while the lower tension display responds only to the terminal block wiring for channel 2. The field wiring connects to the unit on the rear and underside of the enclosure. Terminal blocks are referenced both by the external label located underneath each bank of terminal blocks and by terminal block numbers located on the top of the terminal block banks.

Isolated analog inputs require signal-conditioning modules. The optional analog input modules (Appendix D) supply isolation and a variety of signal conditioning options. The analog input channels 1 and 2 are factory configured to accept 4-20 mA inputs. The LCI-100 can accept only two analog inputs. Each different input type requires a specific hardware configuration setting (see Appendix C).

Tension sensors can be externally powered from the auxiliary DC output 24VDC located on the barrier blocks mounted on the rear of the display. Option 43 must be specified. The factory configuration internally connects the auxiliary DC output COM to the CH (1-2) LO.

Below are the wiring diagrams for the different sensor types and excitation scenarios.

Direct Input – 4-20 mA, Three Wire, Channel 1

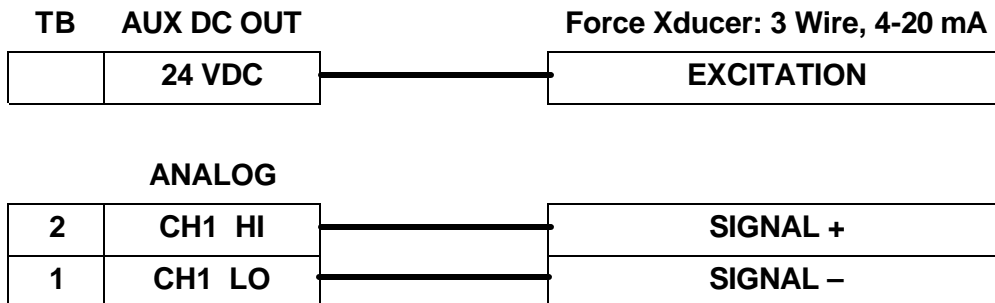

Note: 24V COM internally connected to CH1 LO.

Figure 4.5 – Tension 1 Hookup – 3 Wire 4-20 mA Signal

Direct Input – 4-20 mA, Three Wire, Channel 2

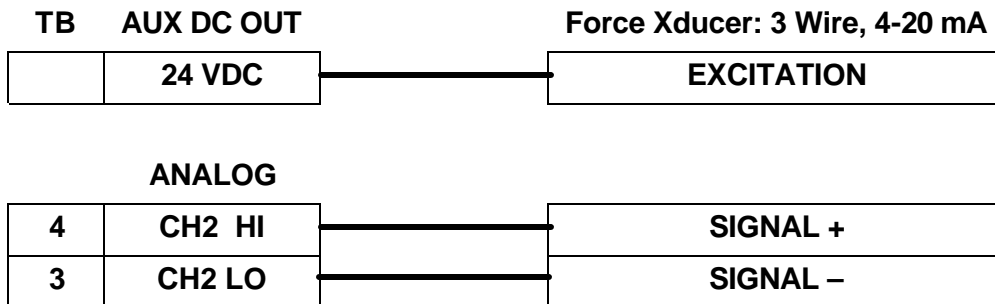

Note: 24V COM internally connected to CH1 LO.

Figure 4.6 – Tension 2 Hookup – 3 Wire 4-20 mA Signal

Direct Input – 4-20 mA, Four Wire, Channel 1

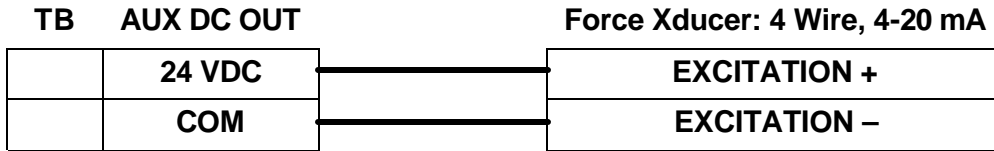

ANALOG

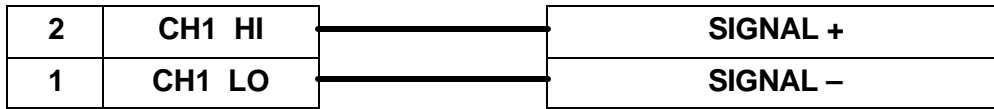
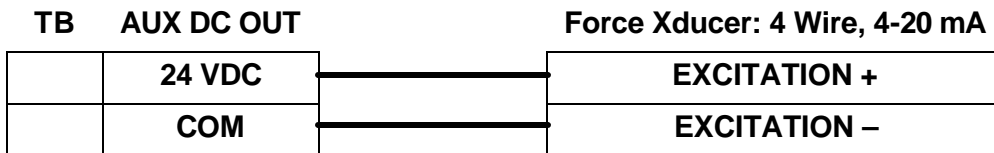

Figure 4.7 – Tension 1 Hookup – 4 Wire 4-20 mA Signal

Direct Input – 4-20 mA, Four Wire, Channel 2



ANALOG

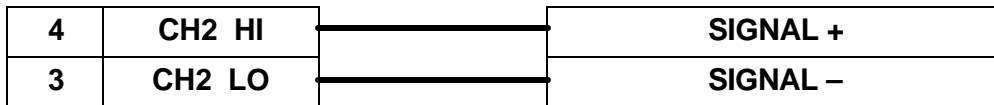
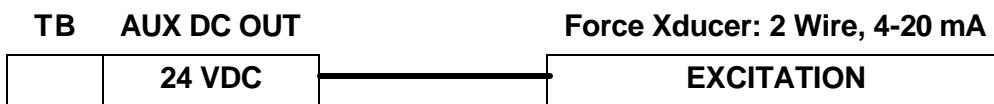

Figure 4.8 – Tension 2 Hookup – 4 Wire 4-20 mA Signal

Direct Input – 4-20 mA, Two Wire, Channel 1



ANALOG



Note: 24V COM internally connected to CH1LO.

Figure 4.9 – Tension 1 Hookup – 2 Wire 4-20 mA Signal

Direct Input – 4-20 mA, Two Wire, Channel 2

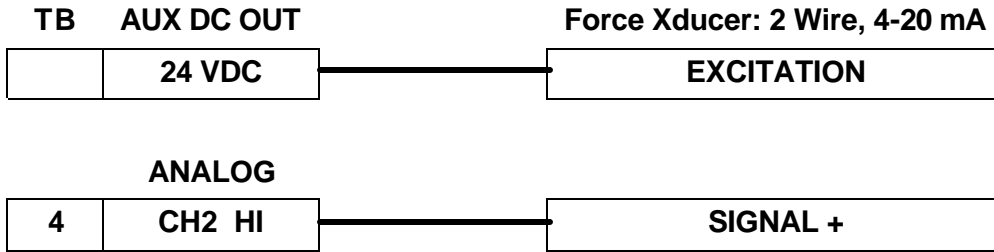

Note: 24V COM internally connected to CH1LO.

Figure 4.10 – Tension 2 Hookup – 2 Wire 4-20 mA Signal

Direct Input – DC Voltage, +24 Volt Excitation, Channel 1

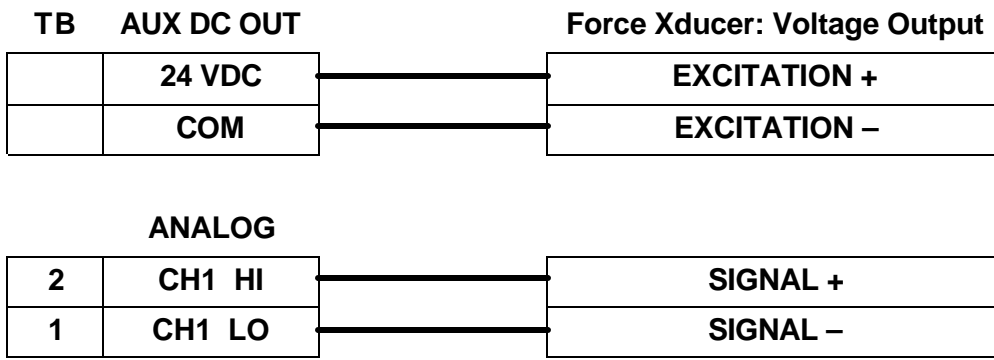

Figure 4.11 – Tension 1 Hookup – 4 Wire DC Voltage Input

Direct Input – DC Voltage, +24 Volt Excitation, Channel 2

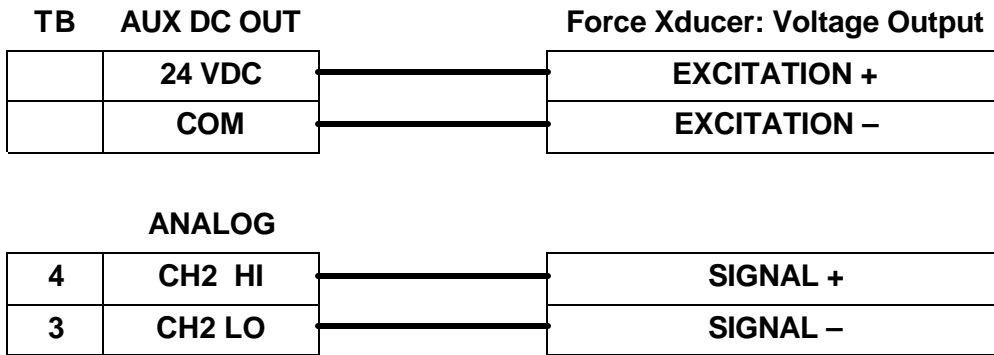
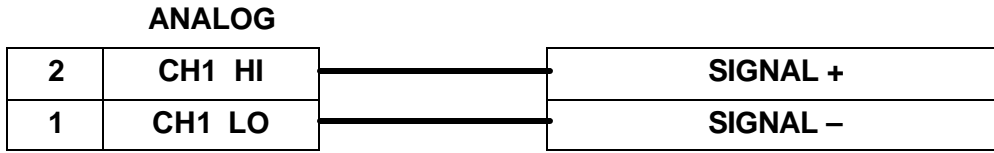
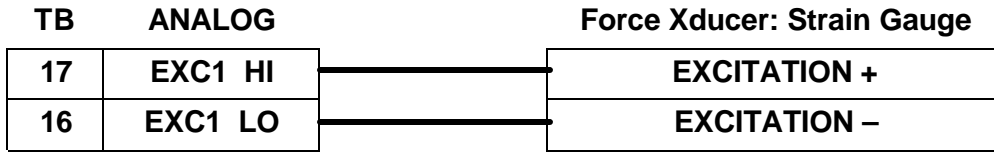

Figure 4.12 – Tension 2 Hookup – 4 Wire DC Voltage Input

Isolated Input – 4 Wire Strain Gauge with Module Channel 1



Note: 4 wire strain gauge module must be inserted in correct position.

Figure 4.13 – Tension 1 Hookup – 4 Wire Strain Gauge

Isolated Input – 4 Wire Strain Gauge with Module Channel 2

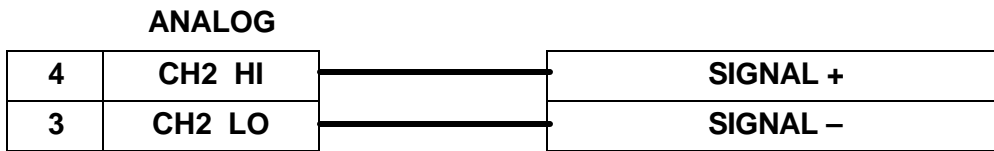
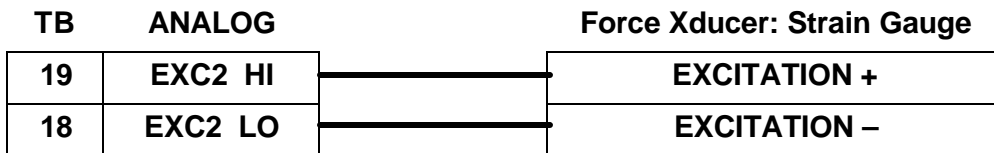

Note: 4 wire strain gauge module must be inserted in correct position.

Figure 4.14 – Tension 2 Hookup – 4 Wire Strain Gauge

Isolated Input – 4-20 mA Isolated Process Current Loop with Module Channel 1



Note: 2 wire 4-20 process current loop module must be inserted in correct position.

Figure 4.15 – Tension 1 Hookup – Isolated 2 Wire 4-20 mA Signal

Isolated Input – 4-20 mA Isolated Process Current Loop with Module Channel 2

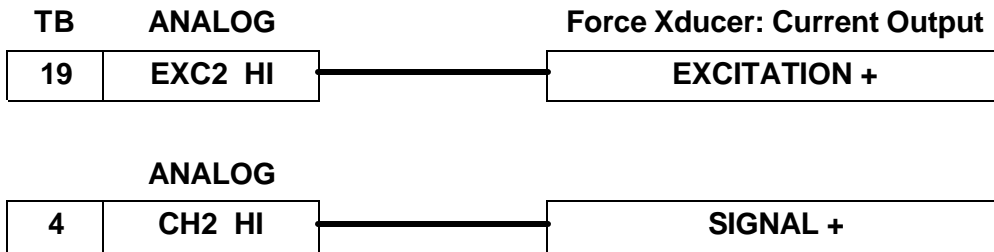

Note: 2 wire 4-20 process current loop module must be inserted in correct position.

Figure 4.16 – Tension 2 Hookup – Isolated 2 Wire 4-20 mA Signal

4.1.3 Alarm Outputs

The eight alarm outputs are terminated on the Digital terminal block bank. The LCI-100 requires optional SM-type optically isolated output modules to implement the alarm outputs. These are available in both solid state and hard contact types with a variety of voltage and current ratings. The wiring diagram below matches the Opto Module number with the corresponding terminal block designation on the Digital terminal block bank. Note that the **Input Check** alarm (§6.3.1) also uses Opto 1, and the **Shunt Cal** relay (§4.1.4, §5.8.1, §5.9.1) uses Opto 8.

Alarm Outputs (8 channels total, channels 1, 2, 8 shown)

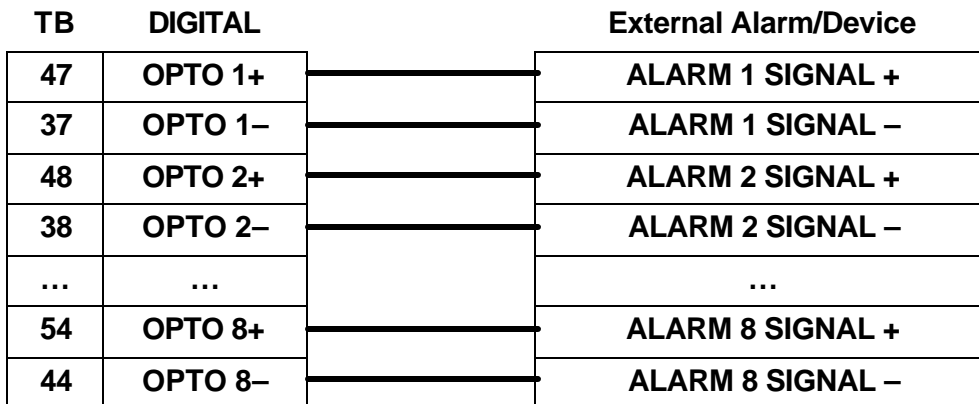

Note: Associated output modules must be installed in the correct position.

Figure 4.17 – Alarm Output Hookup – 8 Channels

4.1.4 Shunt Calibration

The LCI-100 provides a method for “shunt calibration” of a load cell or load pin for each tension input. The sensor must have an internal relay that connects a precision resistor across one leg of the bridge. The LCI-100 uses the Opto 8 output module to energize this relay.

Shunt Calibration Connections

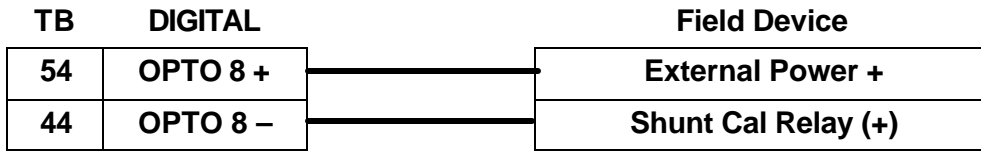

Note: Shunt Cal relay must be referenced to external power common.

Figure 4.18 – Shunt Calibration Hookup

4.1.5 Analog Outputs

The LCI-100 provides two non-isolated analog outputs, or up to four isolated analog outputs using signal conditioning modules. In both cases these outputs can be 4-20 mA, 0-5 Vdc, ±5 Vdc or 0-10 Vdc. Each different output type requires a specific hardware jumper setting on the interface PCB (see Appendix B). Below are wiring diagrams for the different output types.

Direct Output – 2 Channels, Non Isolated

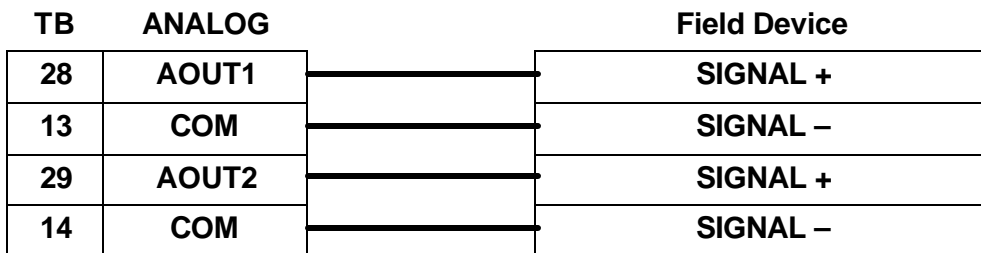

Note: Voltage or current output depends on jumper setting on CPU

Figure 4.19 – Non-isolated Analog Output Hookup

The 4-20 mA non-isolated analog outputs have the ability to be driven by either an internal 15 Vdc power source or by an external power source (nominally 24 Vdc). Units are factory configured for internal power. Below are the wiring diagrams for the external option.

External Power to Drive Non-isolated 4-20 mA Analog Outputs

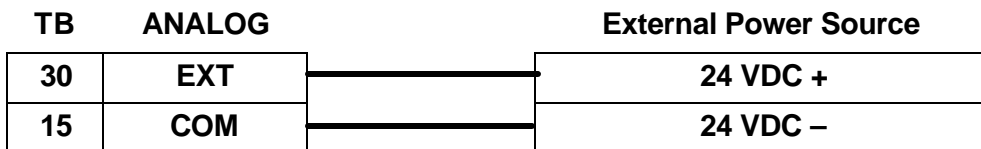

Figure 4.20 – Non-isolated Analog Output Hookup

Isolated Outputs (associated Module must be installed)

TB	ANALOG		Field Device/Data Logger
6	CH3 HI	—————	CHANNEL 1 SIGNAL +
5	CH3 LO	—————	CHANNEL 1 SIGNAL –
8	CH4 HI	—————	CHANNEL 2 SIGNAL +
7	CH4 LO	—————	CHANNEL 2 SIGNAL –
10	CH5 HI	—————	CHANNEL 3 SIGNAL +
9	CH5 LO	—————	CHANNEL 3 SIGNAL –
12	CH6 HI	—————	CHANNEL 4 SIGNAL +
11	CH6 LO	—————	CHANNEL 4 SIGNAL –

Note: Associated output module must be installed in correct position and hardware jumpers correctly configured.

Figure 4.21 – Isolated Analog Output Hookup – 4 Channels

4.1.6 Serial Communications

The LCI-100 provides both RS-232 and RS-485 serial communication options with a maximum of two ports. The base model has no serial ports. A RS-232 network port can be added for data logging to a single remote device in close proximity. For long cable runs or multi-drop applications, this option can be replaced by an electrically-isolated RS-485 port. An auxiliary RS-232 port is also available for serial output to user-supplied logging or display devices.

The RS-485 serial termination is set using the hardware jumper settings on the interface PCB as shown in Appendix B.

The RS-232 network and auxiliary ports are accessed via 10-pin ribbon cable connectors on the side of the unit. Cable pinouts are supplied with these options. The wiring diagram for the RS-485 network port is shown below.

RS-485 Connection – 2 Wire

NETWORK RS485		Remote Device
T-/R-	—————	Network, T-/R-
SHLD	—————	Cable Shield
T+/R+	—————	Network, T+/R+

Figure 4.22 – RS-485 Network Communication Hookup

4.2 Wiring Hookup – LCI-90R Remote Display

A LCI-90R remote can be used to independently display (and optionally echo) all the line variables measured by a LCI-100. The LCI-90R does not support field I/O and thus has a much reduced wiring and configuration specification compared to the LCI-100. This section describes the wiring and other options associated with the LCI-90R.

4.2.1 LCI-90R display power and fuse

The LCI-90R can accept either DC power (standard) or AC power (optional). The fuse, F1, is located on the rear panel of the display. Use a flat blade screwdriver to open the cover for access. The replacement part is a 5 x 20 mm fuse rated according to the system options. See the table below for fuse sizing.

Model No	Fuse Rating	Littlefuse Part No
LCI-90R-DC	5/8 A	216.630
LCI-90R-AC	1/2 A	216.500

Figure 4.23 – Remote Display Fuse rating and replacement part

The standard LCI-90R requires an 18-36 Vdc power source. The optional AC- powered unit requires an 85-265 Vac, 47-440Hz power source. The connection diagrams for these two power options are shown below.

DC Power Connection

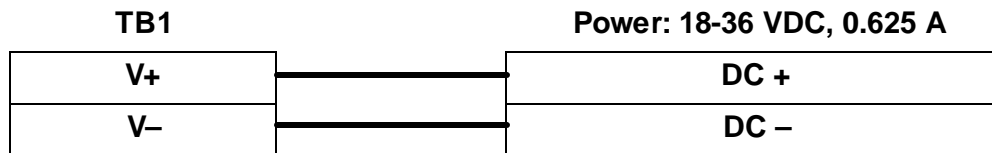

Figure 4.24 – Remote Display Power Hookup – DC Power

AC Power Connection (requires AC Power Option)

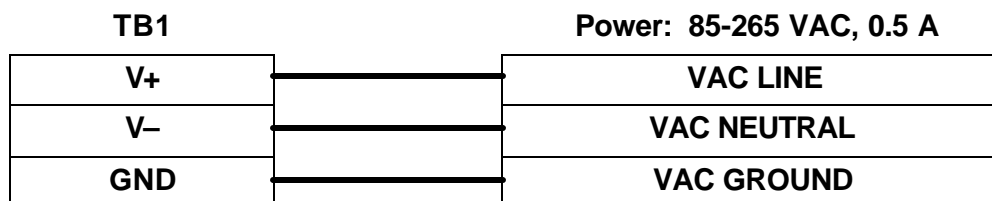

Figure 4.25 – Remote Display Power Hookup – AC Power

4.2.2 LCI-90R communication ports

The LCI-90R provides two serial communication ports on TB2, the network and the auxiliary ports. The connection to the LCI-100 is made via the network port, which is factory configured as either RS-232 (standard) or RS-485 (optional). The RS-232 configuration is suitable when the LCI-100 is connected to a single LCI-90R remote within 50 feet. If multiple remote displays are to be used, or if the network cabling distance is over 50 feet, the RS-485 option should be used. The auxiliary port is RS-232, which can be configured via the Remote Setup feature described in Section 5.6 to transmit line variables to logging or display devices using a variety of protocols. Below are the wiring diagrams for the LCI-90R serial ports.

RS-232 Connection – Auxiliary Port

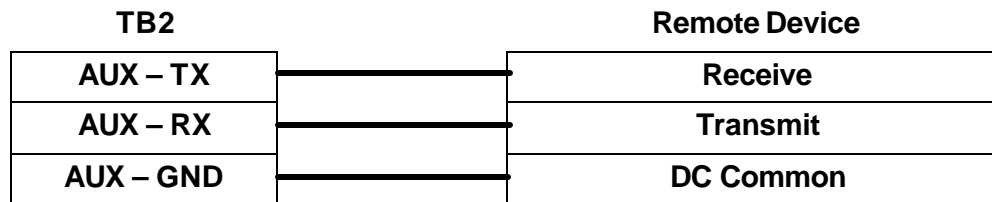

Figure 4.26 – LCI-90R Auxiliary RS-232 Hookup

RS-232 Connection – Network Port

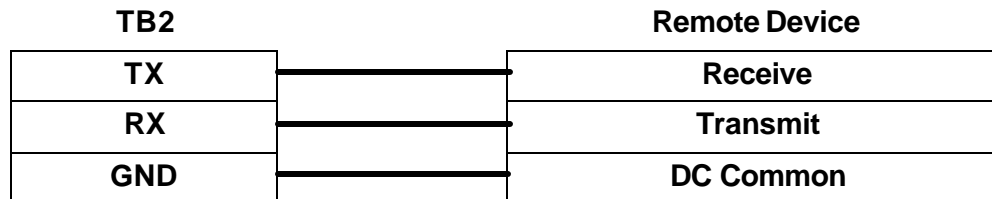
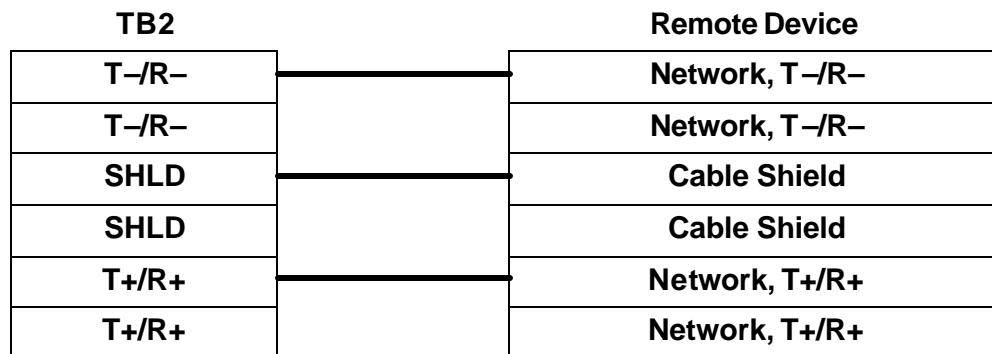

Figure 4.27 – LCI-90R Network RS-232 Hookup

RS-485 Connection – Network Port (requires RS-485 option)



Note: Duplicate terminal blocks are for daisy-chaining multiple units.

Figure 4.28 – LCI-90R Network RS485 Hookup

4.2.3 LCI-90R display brightness adjustment

The display brightness on the LCI-90R HT model can be varied by using SW-2 on the rear panel to change the scan rate, or by adjusting the rotary potentiometer (also on the rear panel) marked DISP. The DIP switch settings are described in Appendix B.

Varying the DISP potentiometer is most effective on the higher scan rates. Decreasing the brightness prolongs the life of the screen.

5.0 Local Display Operation

5.1 Front Panel Identification

The LCI-100 front panel, shown in Figure 5.1, features a high visibility display and a five-button keypad. Each key has a label at the bottom of the screen that identifies its function. When a key is pressed its function (and the label) changes to reflect the current “operating mode” of the instrument.

In normal operation the RUN screen (shown below) is displayed. This screen is divided into two separate displays Upper and Lower, which are defined as Tension 1 (Line 1) and Tension 2 (Line 2) respectively. Each display includes a bar graph with operator selectable limits and a visual indication of alarm setpoints. Alarm message displays are located below the parameter displays. Up to six alarm conditions can be shown in this area.

The function of the five menu keys during RUN mode are as follows:

- MENU** Displays the menu for programming and/or calibration of the unit. Section 5.2 describes the navigation and data editing within the programming menu
- DIAG** Switches to the diagnostics screen which shows raw sensor inputs and scaled Tension values of Line 1 and Line 2. Once in DIAG mode, the same button (now labeled **MAIN**) returns the display to the RUN screen.
- ALRM** If an alarm condition is present, this button will reset all alarm output modules. Double-pressing this button within a two-second interval will bring up the **1.0 SET ALARMS** menu (§5.3.2)
- CAL 1** Acts as a shortcut to the **2.0 CALIBRATION LINE 1** menu (§5.4).
- CAL 2** Acts as a shortcut to the **3.0 CALIBRATION LINE 2** menu (§5.5).

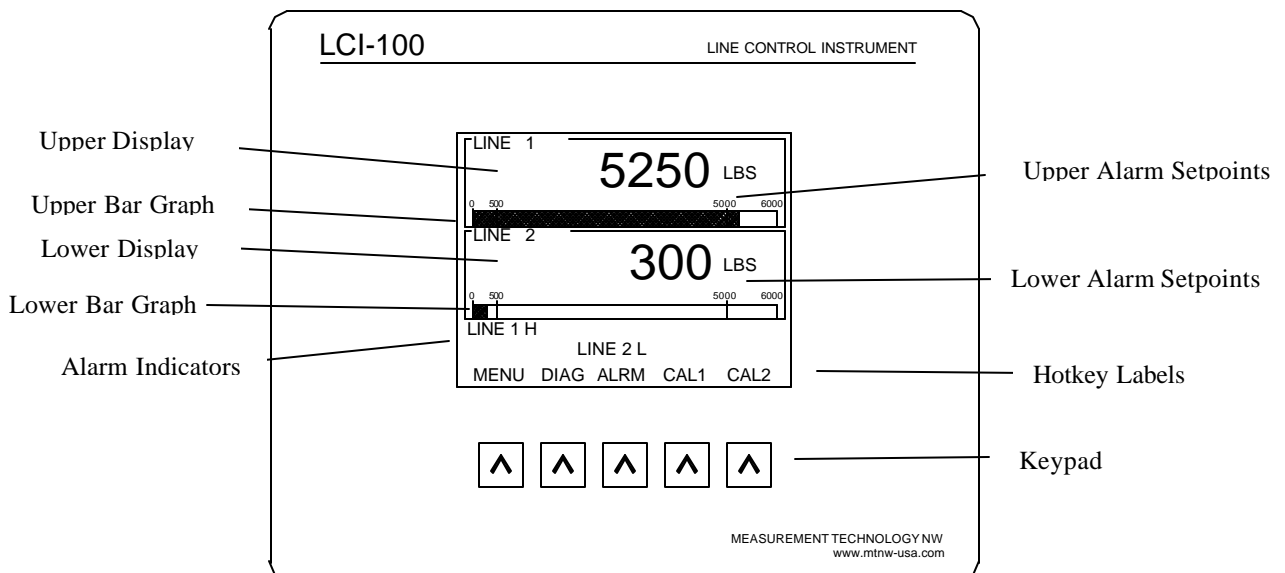

Figure 5.1 – LCI 100 Front Panel

5.2 Programming Menu

The LCI-100 is user programmable via the front panel keypad and the display. Programming options include selection of input/output signal ranges, setting screen displays and formats, defining alarm points, and calibrating the unit. The menu tree is shown below in Figure 5.2.

Pressing the **MENU** key displays the **0 MAIN MENU** screen. The key labels also change to indicate the functions they perform in **Menu** mode, allowing the user to navigate through the menu system and select menu items. Once an item is selected, the keypad labels change again to reflect their uses in **Edit** mode for modifying data fields.

In Menu mode the keys have the following labels and functions:

RUN	UP	DOWN	ENT	ESC
------------	-----------	-------------	------------	------------

- RUN** Returns to the Run Display, saving any changes made to menu items
- UP** Moves pointer up the menu (wraps to the bottom)
- DOWN** Moves pointer down the menu (wraps to the top)
- ENT** If the pointer indicates a sub-menu, jumps to that menu. If the pointer indicates a data field, enters **Edit** mode to allow changes on the selected field (see below).
- ESC** Moves back one menu level. When reaching the top menu, displays the message: **DISCARD CHANGES? NO YES**. Pressing **ESC** (under the **YES** label) will discard all changes made while in the menu and return to Run mode

When a data field is selected with the **ENT** key, the labels and functions of the keypad change to **Edit** mode as shown below.

DECR	INCR	→	ENT	ESC
-------------	-------------	----------	------------	------------

- DECR** Decreases the selected digit by one when editing a numeric field, or reverse scrolls through a list of available options.
- INCR** Increases the selected digit by one when editing a numeric field, or scrolls through a list of the available options.
- Moves the edit cursor to next digit in data field, or scrolls through a list of choices.
- ENT** Accepts the edited value and returns to **Menu** mode
- ESC** Rejects the edited value and return to **Menu** mode

Here is an overview of the LCI-100 menu system:

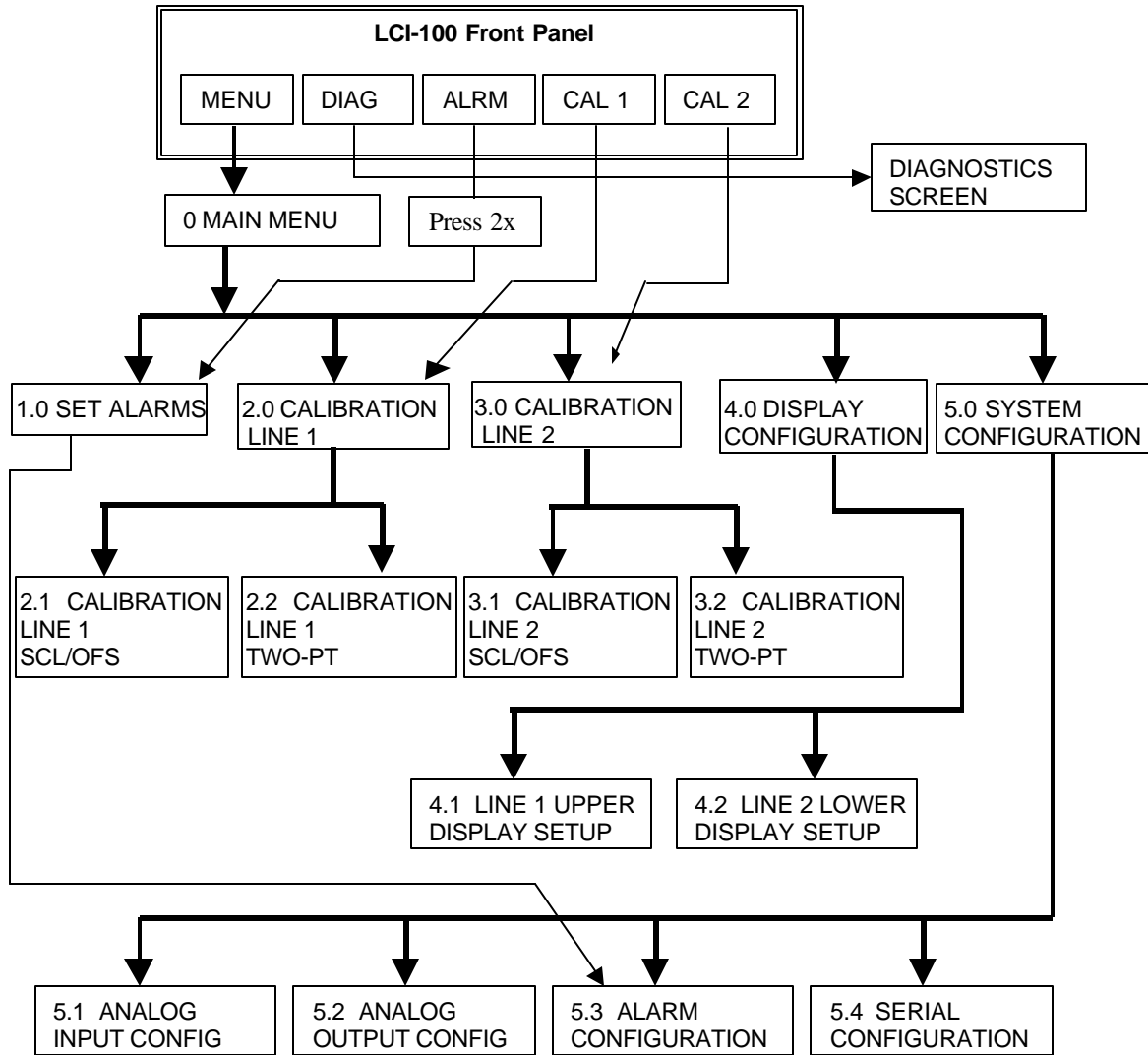

Figure 5.2 – LCI 100 Menu Tree

5.3 Alarms

The LCI-100 provides the user with up to six optional visual alarms that can be configured to indicate high and low conditions of Line 1 and Line 2. Each alarm can be assigned to any of these two measured variables, and can be designated as a high or low alarm. Each alarm can also be assigned to any one of the eight opto output modules that could be used to drive lights and/or horns. (Opto 8 is reserved for shunt calibration.)

The lower third of the Run Display is reserved for alarm messages. The alarm messages correspond to how the user configured them. Figure 5.3 below is an example display of alarms 1-2 being configured as low Tension 1 alarms, alarm 3 configured as Line 1 high alarm, alarm 4 configured as Line 2 low alarm, alarm 5 configured as Line 2 high alarm and alarm 6 unused. It would be unlikely to have all these messages on the display at one time, but each has its own location to prevent them from overwriting each other.

LINE 1 L	LINE 1 L	LINE 1 H
LINE 2 L	LINE 2 H	

Figure 5.3 – Sample Alarm Message Display

Two separate menus are used for alarms. One menu is dedicated to adjusting alarm limits only and is described in Section 5.3.2. This menu can be reached from the front panel by pressing the **ALRM** key **twice within two seconds**. A separate menu is used when setting up the instrument to identify the alarm variable and type, enable opto outputs, and set the deadband for each channel. This alarm configuration menu is covered in Section 5.3.3.

In addition to these six high-level alarms, the LCI-100 can be configured to monitor each analog input channel, watching for a low-level fault condition. This is particularly useful with multiple input configurations, where the failure of a single sensor might not be easily noticed. Enabling and responding to the **input check** alarms is described in Sections 6.3.1.

5.3.1 Acknowledging alarms

When an alarm event occurs a message appears in the lower part of the Run Screen identifying the source of the alarm. This message remains on the screen as long as the alarm condition exists. When the variable causing the alarm changes to a value beyond the dead-band range, the message will go away. If the user configures the alarm to output to a relay module, that module will track the screen display: it will energize when the alarm event occurs and de-energize when the condition goes away. (If multiple alarms use the same output module, then all alarm conditions must clear before the relay will de-energize.)

Pressing the **ALRM** key after an alarm condition occurs de-energizes all the modules currently energized. They will remain de-energized until a new alarm condition is generated. Note that even when an alarm is acknowledged by pressing the **ALRM** key, the on-screen message remains until the condition goes away.

When an alarm condition occurs, two quick presses on the **ALRM** key will still go directly to the **1.0 SET ALARMS** menu. This makes it convenient to view or correct alarm limits to prevent nuisance alarms.

5.3.2 Setting alarm limits

From the RUN screen push the **ALRM** key twice within 2 seconds, or press **MENU** and select the **1.0 SET ALARMS** (shown below). Upper limits are indicated by a greater-than sign “>”, and lower limits by a less-than sign “<”. Press **ENT** to change the set point using the **DECR, INCR** and **key** → Save the change with the **ENT** key. Keep the old value with the **ESC** key. Push the **RUN** key to return to the Run screen. To check or alter the configuration of the alarm settings choose item 7, or go to Menu **5.3 ALARM CONFIGURATION**.

1.0 SET ALARMS			
> 1	LINE 1	>	10000 TONS
2	LINE 1	>	8000 TONS
3	LINE 2	>	2500 LBS
4	LINE 2	<	100 LBS
5	LINE 2	>	250 LBS
6	NONE		
7	CHANGE CONFIGURATION		

5.3.3 Configuring Alarms

To configure the alarm settings, go to menu **5.3 ALARM CONFIGURATION** shown below by pressing the **MENU** key from the RUN screen and navigating through the menu (or by selecting Item 7 in the **1.0 SET ALARMS** menu above).

5.3 ALARM CONFIGURATION			
> 1	ALARM NO.		1
2	VARIABLE		LINE 1
3	OUTPUT TO		SCR+OP2
4	ALARM TYPE		HIGH
5	LIMIT		1000 LBS
6	DEADBAND		20 LBS

- Item 1 Directs the configuration to alarm numbers 1–6. Edit this field first to view the information for the desired alarm channel
- Item 2 Sets the alarm to monitor Line 1 or Line 2. There are no limits to how many of the six channels can be assigned to each variable.
- Item 3 Relates the alarm condition to an opto output module as shown in the table below. There is no requirement for each alarm to have its own module. All alarms can be assigned to a single module that energizes a horn, if so desired. Conversely, alarms can be configured to only appear on the screen. Note that the Input Check Alarm (§6.3.1) always uses output module 1, and the Shunt Cal relay (§5.8, §5.9) always uses output module 8.

Setting	Hardware/Terminal Block
OP1	OPTO Module 1 / OPTO 1 ±
OP2	OPTO Module 2 / OPTO 2 ±
OP3	OPTO Module 3 / OPTO 3 ±
OP4	OPTO Module 4 / OPTO 4 ±

Figure 5.4 – Digital Output Module Locations and Menu Names, 4 of 8 Channels Shown

Once the calibration values have been entered, press **RUN** to save the values and return to the run screen, or to discard the changes, press **ESC** until the message **DISCARD CHANGES? NO YES** appears, and choose **YES**.

5.4.2 Two point live calibration – Line 1

The two point live calibration method allows the Line 1 input to be calibrated using actual weights or measured line Tensions in the field. The two-point live calibration automatically calculates the Scale and Offset values described in section 5.4.1, based on the applied weights. When you perform a two-point live calibration, the previous Scale and Offset values are automatically updated to reflect the new calibration. This eliminates the chance of conflicting calibration values in the two modes. If the existing numbers are significant, they should be recorded before beginning this procedure.

The menu for using the two point live calibration functions, **2.2 CALIBRATION – LINE 1**, is shown below. Two known Tension loads are required to perform this calibration. Ideally these loads are near each end of the normal working load range, but not at either full-load or zero load.

2.2 CALIBRATION – LINE 1		
> 1	CALIB MODE	TWO-PT
2	DISPLAY LO	50 TONS
3	DISPLAY HI	9500 TONS
4	LIVE/EDIT	LIVE
5	INPUT LO	0.126 V
6	INPUT HI	4.873 V

Perform this calibration as follows:

- 1) Apply known or measured **LOW** Line 1 to the cable.
- 2) Move to Item 2 using the **DOWN** key and press **ENT**. Edit the **DISPLAY LO** value to correspond to the applied load. Press **ENT** when complete.
- 3) Move to Item 5 using the **DOWN** key and press **ENT**. The number shown will be a real-time measurement of the input signal. It should be near the low end of its full range for low loading conditions. The message above the keypad now reads: **PRESS ENT TO GRAB ENT ESC**. Once the reading has stabilized, press **ENT** to grab the value, or **ESC** to cancel the reading.
- 4) Repeat, applying a known or measured **HIGH** Line 1 to the cable.
- 5) Move to Item 3 using the **UP** key and press **ENT**. Edit the **DISPLAY HI** number to correspond to the applied load. Press **ENT** when complete.
- 6) Move to Item 6 using the **DOWN** key and press **ENT**. The number shown will be a real-time measurement of the input signal. It should be near the high end of its full range for high loading conditions. The message above the keypad now reads: **PRESS ENT TO GRAB ENT ESC**. Once the reading has stabilized, press **ENT** to grab the value, or **ESC** to cancel the reading.

5.5.2 Two point live calibration – Line 2

The two point live calibration method allows the Line 2 input to be calibrated using actual weights or measured line Tensions in the field. The two-point live calibration automatically calculates the Scale and Offset values described in section 5.5.1, based on the applied weights. When you perform a two-point live calibration, the previous Scale and Offset values are automatically updated to reflect the new calibration. This eliminates the chance of conflicting calibration values in the two modes. If the existing numbers are significant, they should be recorded before beginning this procedure.

The menu for using the two point live calibration functions, **3.2 CALIBRATION – LINE 2**, is shown below. Two known Tension loads are required to perform this calibration. Ideally these loads are near each end of the normal working load range, but not at either full-load or zero load.

3.2 CALIBRATION – LINE 2		
> 1	CALIB MODE	TWO-PT
2	DISPLAY LO	50 TONS
3	DISPLAY HI	9500 TONS
4	LIVE/EDIT	LIVE
5	INPUT LO	0.126 V
6	INPUT HI	4.873 V

Perform this calibration as follows:

- 9) Apply known or measured **LO**w Line 2 to the cable.
- 10) Move to Item 2 using the **DOWN** key and press **ENT**. Edit the **DISPLAY LO** value to correspond to the applied load. Press **ENT** when complete.
- 11) Move to Item 5 using the **DOWN** key and press **ENT**. The number shown will be a real-time measurement of the input signal. It should be near the low end of its full range for low loading conditions. The message above the keypad now reads: **PRESS ENT TO GRAB ENT ESC**. Once the reading has stabilized, press **ENT** to grab the value, or **ESC** to cancel the reading.
- 12) Repeat, applying a known or measured **High** Line 2 to the cable.
- 13) Move to Item 3 using the **UP** key and press **ENT**. Edit the **DISPLAY HI** number to correspond to the applied load. Press **ENT** when complete.
- 14) Move to Item 6 using the **DOWN** key and press **ENT**. The number shown will be a real-time measurement of the input signal. It should be near the high end of its full range for high loading conditions. The message above the keypad now reads: **PRESS ENT TO GRAB ENT ESC**. Once the reading has stabilized, press **ENT** to grab the value, or **ESC** to cancel the reading.
- 15) While not recommended, there may be occasions where it would be helpful to numerically edit the **INPUT LO** and **INPUT HI** fields. This is possible by moving to Item 4, and changing it from **LIVE** to **EDIT**. This will allow the **INPUT HI** and **LO** values to be edited like any other menu item.
- 16) Press the **RUN** key to apply the two-point linear fit to the scale and offset values and save the results. To abort the calibration and keep the current settings, press **ESC** until you are prompted to lose changes and press **YES**

5.6 Tension Tare – Line 1

To perform a tare on Line 1, press **CAL 1** to display the main **2.0 CALIBRATION – LINE 1** menu, shown below. Select Item 2 and press **ENT** to activate the edit keys. Press either **INCR** or **DECR** to toggle between **ON** and **OFF**. Press **ENT** to accept the selection. When Tension Tare is turned **ON**, the tension input **at that moment** for Tension channel 1 will be saved and subtracted from all future displayed values. To warn the user that the displayed value is not the real tension (which could be much higher!), an asterisk (*) is displayed after the LINE 1 label. When Tension Tare is turned **OFF** the tare value (and the asterisk) are removed, and the actual tension is again displayed.

2.0 CALIBRATION – LINE 1		
1	LINE 1 (TWO METHODS)	
> 2	TENSION TARE	ON
3	SHUNT CAL	OFF
4	WRAP ANGLE	120 DEG

5.6.1 Tension Tare – Line 1

The tare function is a way to zero a small displayed tension value. Care should be taken when using the tare function as the displayed value does not reflect actual line tension but rather line tension minus the tare value. Any alarms that are set to monitor the tension input will be triggered by the actual line tension value, not the displayed value. The tare function can be deactivated at any time, returning the unit to its normal tension display.

5.7 Tension Tare – Line 2

To perform a tare on Line 1, press **CAL 2** to display the main **3.0 CALIBRATION – LINE 2** menu, shown below. Select Item 2 and press **ENT** to activate the edit keys. Press either **INCR** or **DECR** to toggle between **ON** and **OFF**. Press **ENT** to accept the selection. When Tension Tare is turned **ON**, the tension input **at that moment** for Tension channel 2 will be saved and subtracted from all future displayed values. To warn the user that the displayed value is not the real tension (which could be much higher!), an asterisk (*) is displayed after the LINE 2 label. When Tension Tare is turned **OFF** the tare value (and the asterisk) are removed, and the actual tension is again displayed.

3.0 CALIBRATION – LINE 2		
1	LINE 2 (TWO METHODS)	
2	TENSION TARE	ON
3	SHUNT CAL	OFF
4	WRAP ANGLE	120 DEG

5.7.1 Tension Tare – Line 2

The tare function is a way to zero a small displayed tension value. Care should be taken when using the tare function as the displayed value does not reflect actual line tension but rather line tension minus the tare value. Any alarms that are set to monitor the tension input will be triggered by the actual line tension value, not the displayed value. The tare function can be deactivated at any time, returning the unit to its normal tension display.

5.8 Shunt Calibration – Line 1

To perform a shunt calibration on tension channel 1, press **CAL 1** to display the main **2.0 CALIBRATION – LINE 1** menu shown below. Select Item 3 and press **ENT** to activate the edit keys. Press either **INCR** or **DECR** to toggle between **ON** and **OFF**. Press **ENT** to accept the selection. At this time the contacts on the Opto 8 module will either be closed (**ON**) or opened (**OFF**).

2.0 CALIBRATION – LINE 1		
1	LINE 1 (TWO METHODS)	
2	TENSION TARE	OFF
3	SHUNT CAL	ON
4	WRAP ANGLE	120 DEG

5.8.1 Shunt Calibration – Line 1

The Shunt Cal function requires a load pin or cell with an internal relay that, when energized, connects a precision resistor in parallel with one leg of the bridge. This perturbation simulates a known change in tension, which can be used to verify the calibration of the unit. Setting Shunt Cal to ON closes the contacts of the DC output module installed in the Opto 8 slot. A 24VDC relay in the load pin is appropriate.

5.9 Shunt Calibration – Line 2

To perform a shunt calibration on Line 2, press **CAL 2** to display the main **3.0 CALIBRATION – LINE 2** menu shown below. Select Item 3 and press **ENT** to activate the edit keys. Press either **INCR** or **DECR** to toggle between **ON** and **OFF**. Press **ENT** to accept the selection. At this time the contacts on the Opto 8 module will either be closed (**ON**) or opened (**OFF**).

3.0 CALIBRATION – LINE 2		
1	LINE 2 (TWO METHODS)	
2	TENSION TARE	OFF
> 3	SHUNT CAL	ON
4	WRAP ANGLE	120 DEG

5.9.1 Shunt Calibration – Line 1

The Shunt Cal function requires a load pin or cell with an internal relay that, when energized, connects a precision resistor in parallel with one leg of the bridge. This perturbation simulates a known change in tension, which can be used to verify the calibration of the unit. Setting Shunt Cal to ON closes the contacts of the DC output module installed in the Opto 8 slot. A 24VDC relay in the load pin is appropriate.

5.10 Wrap Angle – Line 1

To set the correct wrap angle for a single-axis load-pin for a tension input on Line 1, press **CAL 1** to display the main **2.0 CALIBRATION – LINE 1** menu. Select Item 4 and press **ENT** to activate the edit keys. Use the **INCR**, **DECR** and **←** **→** keys to change the value. Press **ENT** to save the new value or **ESC** to cancel the changes.

2.0 CALIBRATION – LINE 1		
1	LINE 1 (TWO METHODS)	
2	TENSION TARE	OFF
3	SHUNT CAL	OFF
> 4	WRAP ANGLE	120 DEG

5.10.1 Wrap angle adjustments – Line 1

The LCI-100 has the ability to correct for variations in sheave geometry by allowing the user to specify the wrap angle. (See §13 for a definition of this angle, and a table showing the effect it has on the measured tension.) The wrap angle correction only applies to fixed sheave angle geometries; if this angle varies (for example, a sheave mounted on a movable boom, or a load that swings through an arc), a dual-axis load pin, or a direct line-tension sensor is required to get accurate results.

In practical situations the wrong wrap angle can lead to a 40-50% error in the readout unless the LCI-100 is calibrated using the two-point live method described in §5.4.1. The two-point method automatically adjusts the scale and offset values to compensate for fixed wrap angles. For maximum accuracy with live calibrations (or for tension measurements that do not involve wrap angle), this item should be set to 120° (the factory default value).

5.11 Wrap Angle – Line 2

To set the correct wrap angle for a single-axis load-pin for a tension input on Line 2, press **CAL 2** to display the main **3.0 CALIBRATION – LINE 2** menu. Select Item 4 and press **ENT** to activate the edit keys. Use the **INCR**, **DECR** and **←** **→** keys to change the value. Press **ENT** to save the new value or **ESC** to cancel the changes.

3.0 CALIBRATION – LINE 2		
1	LINE 2 (TWO METHODS)	
2	TENSION TARE	OFF
3	SHUNT CAL	OFF
> 4	WRAP ANGLE	120 DEG

5.11.1 Wrap angle adjustments – Line 2

The LCI-100 has the ability to correct for variations in sheave geometry by allowing the user to specify the wrap angle. (See §13 for a definition of this angle, and a table showing the effect it has on the measured tension.) The wrap angle correction only applies to fixed sheave angle geometries; if this angle varies (for example, a sheave mounted on a movable boom, or a load that swings through an arc), a dual-axis load pin, or a direct line-tension sensor is required to get accurate results.

In practical situations the wrong wrap angle can lead to a 40-50% error in the readout unless the LCI-100 is calibrated using the two-point live method described in §5.4.1. The two-point method automatically adjusts the scale and offset values to compensate for fixed wrap angles. For maximum accuracy with live calibrations (or for tension measurements that do not involve wrap angle), this item should be set to 120° (the factory default value).

5.12 Display Configuration

The LCI-100 allows the user to change the units of measure, and the number of decimal places for each Line tension input. The location of the two parameters is fixed such that the upper is Line 1 and the lower is Line 2. They can not be modified. The LCI-100 also has a screen saver to prolong the life of the display. These features are accessed via the **4.0 DISPLAY CONFIGURATION** menu. Each of the two line variables, Line 1 and Line 2, has its own sub-menu to customize the readout. These are described in Sections 5.12.1-9 below.

4.0 DISPLAY CONFIGURATION		
> 1	LINE 1 (UPPER) DISPLAY	
2	LINE 2 (LOWER) DISPLAY	
3	SCREEN SAVER	ON

5.12.1 Setting display units – Line 1

The Line 1 input variable can be individually set for several common units. The LCI-100 was designed to be **units-aware**. Any of the display units can be switched during operation without requiring re-calibration. The internal display calculations automatically accommodate the changes. If the RUN screen shows **3000.0 LBS** on the Line 1 display, and the Tension units are changed to **tons**, the screen will immediately display **1.5 TONS** with no other changes necessary.

4.1 LINE 1 DISPLAY SETUP		
> 1	UNITS	LBS
2	DECIMAL PLCS	1
3	FULL SCALE	5000 LBS
4	SMOOTH (0-5)	1

The available Units, and their abbreviations, are listed in the table below. Item 1 in menu **4.1** determines the units used for each line variable. To change the units, scroll through the choices with the **INCR** or **→** keys, and push the **ENT** key when the desired units are displayed.

Variable	Units – Abbreviation
Tension	Pounds – LBS
	Tons – TONS
	Kilopounds – KIPS
	Kilograms – KGMS
	Metric Tons - MTNS

Figure 5.5 – LCI-100 Display Units

5.12.2 Setting decimal places – Line 1

Item 3 in menus **4.1** sets the maximum number of digits displayed to the right of the decimal point for Line 1 variable. To select decimal places scroll through the choices with the **INCR** or **→** keys, and push **ENT** when the desired value is displayed.

Each display variable can be set to have as many as 3 decimal places. If the value has too many digits for the assigned screen location, then trailing decimals are automatically dropped to make the number fit the available space. If the number is still too wide for the assigned space, then the rightmost digits are clipped to make it fit. In this case, the LCI-100 displays “**OL**” on top of the rightmost digit to indicate that the display is over the digit limit for that field. If this happens, consider switching that variable to a different display location or use a different set of units.

5.12.3 Setting Bar Graph Range – Line 1

The top display of the LCI-100 includes a bar graph for visual indication of the current operating condition and is relative to tension input one only. The full scale of the bar graph can be set by the user via item 4 in menus **4.1**. This full scale value is only used for the bar graph upper limit.

The Line 1 has a well-defined full scale limit based on the calibration and the input range of the Tension input channels. This full scale Tension is calculated by the LCI-100 after every calibration operation, automatically updating menu 4.1 Item 3. This ensures that the full scale of the Tension bar graph is the true full scale of the sensor as calibrated. After calibration, the full scale value can be adjusted by the user to change the upper limit on the graph if desired.

5.12.4 Tension Display Smoothing – Line 1

A modified running average filter can be enabled to reduce wave motion effects on the Line 1 display. The amount of smoothing is determined by menu 4.1, Item 4. The available settings range from '0' to '5'. A setting of 0 results in no filter being applied, and a setting of 5 applies the maximum filtering. The higher the setting, the less sensitive the display is to sudden changes. At a setting of 5 a full-scale change will take approximately 15 seconds to “settle out”. A setting of 1 or 2 will “dampen out” most small fluctuations, while still allowing the LCI-100 to respond immediately to large changes.

5.12.5 Setting display units – Line 2

The Line 2 input variable can be individually set for several common units. The LCI-100 was designed to be **units-aware**. Any of the display units can be switched during operation without requiring re-calibration. The internal display calculations automatically accommodate the changes. If the RUN screen shows **3000.0 LBS** on the Line 1 display, and the Tension units are changed to **tons**, the screen will immediately display **1.5 TONS** with no other changes necessary.

4.2 LINE 2 DISPLAY SETUP		
> 1	UNITS	LBS
2	DECIMAL PLCS	1
3	FULL SCALE	5000 LBS
4	SMOOTH (0-5)	1

The available Units, and their abbreviations, are listed in the table below. Item 1 in menu 4.2 determines the units used for each line variable. To change the units, scroll through the choices with the **INCR** or **DECR** keys, and push the **ENT** key when the desired units are displayed.

Variable	Units – Abbreviation
Tension	Pounds – LBS
	Tons – TONS
	Kilopounds – KIPS
	Kilograms – KGMS
	Metric Tons - MTNS

Figure 5.6 – LCI-100 Display Units

5.12.6 Setting decimal places – Line 2

Item 2 in menus **4.2** sets the maximum number of digits displayed to the right of the decimal point for Line 2 variable. To select decimal places scroll through the choices with the **INCR** or **→** keys, and push **ENT** when the desired value is displayed.

Each display variable can be set to have as many as 3 decimal places. If the value has too many digits for the assigned screen location, then trailing decimals are automatically dropped to make the number fit the available space. If the number is still too wide for the assigned space, then the rightmost digits are clipped to make it fit. In this case, the LCI-100 displays “**OL**” on top of the rightmost digit to indicate that the display is over the digit limit for that field. If this happens, consider switching that variable to a different display location or use a different set of units.

5.12.7 Setting Bar Graph Range – Line 2

The top display of the LCI-100 includes a bar graph for visual indication of the current operating condition and is relative to tension input one only. The full scale of the bar graph can be set by the user via item 4 in menus **4.2**. This full scale value is only used for the bar graph upper limit.

Line 2 has a well-defined full scale limit based on the calibration and the input range of the Tension input channels. This full scale Line 2 is calculated by the LCI-100 after every calibration operation, automatically updating menu 4.2 Item 3. This ensures that the full scale of the Tension bar graph is the true full scale of the sensor as calibrated. After calibration, the full scale value can be adjusted by the user to change the upper limit on the graph if desired.

5.12.8 Tension Display Smoothing – Line 2

A modified running average filter can be enabled to reduce wave motion effects on the Line 2 display. The amount of smoothing is determined by menu **4.2**, Item 4. The available settings range from '0' to '5'. A setting of 0 results in no filter being applied, and a setting of 5 applies the maximum filtering. The higher the setting, the less sensitive the display is to sudden changes. At a setting of 5 a full-scale change will take approximately 15 seconds to “settle out”. A setting of 1 or 2 will “dampen out” most small fluctuations, while still allowing the LCI-100 to respond immediately to large changes.

5.12.9 Screen saver

The LCI-100 is equipped with a screen-saver to prolong the life of the display. The screen will go blank after 30 minutes if the unit has not detected an operator key press. To re-energize the display, simply push any front panel button (preferably the **MENU** or **DIAG** buttons on the left). Note that the LCI-90R blind remote has no screen saver, since it has no front panel keypad.

4.0 DISPLAY CONFIGURATION	
1	LINE 1 (UPPER) DISPLAY
2	LINE 2 (LOWER) DISPLAY
> 3	SCREEN SAVER ON

6.0 Hardware Configuration

The LCI-100 will work with a wide variety of input sensors, output alarms and data systems. The **5.0 SYSTEM CONFIGURATION** menu, shown below, allows the LCI-100 to be customized for a particular installation. Once these settings have been made, this menu also offers a security feature that locks out unauthorized changes. Should it happen, however, that unwanted changes to the configuration are made, it is possible to return to the "Factory Setup" configuration, which can be customized for a given installation. The functions of each item in this menu are described in Sections 6.1-6.6.

5.0 SYSTEM CONFIGURATION		
>	1	SECURITY OFF 0
	2	FACTORY SETUP NO
	3	ANALOG INPUTS
	4	ANALOG OUTPUTS
	5	ALARM SETTINGS
	6	SERIAL COMMUNICATION

6.1 Security

Security is either **OFF (0)** or **ON (1)**. When Security is **ON** most of the RUN functions are disabled, i.e. **RSET**, **CAL1**, **CAL2** and **ALRM SET** are locked out. The user can access the DIAG screen(s), and can silence alarms, but all menu items are locked out except for the security option.

To change the Security setting, press **ENT**. This will highlight the default value (0=off, 1= on), and allow the operator to enter a security code. This number can be any value between 2 and 255, which will become the security unlock code, so it should be kept in a safe place. Once a number is entered (and **RUN** is pressed to save the change), the security lockout feature is enabled, and can only be disabled by re-entering the **same number**.

6.2 Factory Setup

This item always defaults to **NO**; pressing **ENT** and changing the value to **YES**, followed by a second **ENT** will immediately restore all configuration parameters to their "Factory Setup" values. This operation should only be necessary in cases where the LCI-100 does not seem to be working properly and it is desired to return to a known configuration in order to perform long-distance troubleshooting. All existing configuration parameters are lost and the display will return to RUN mode automatically after this operation.

6.3 Analog Input Configuration

The various analog input options are configured through menu **5.1 ANALOG INPUT CONFIG**, shown below. Additional hardware modifications are necessary to switch between these sensor inputs. A description of each item in this menu is given below:

5.1 ANALOG INPUT CONFIG		
>	1	CHANNEL NO. 1
	2	INPUT RANGE 0 – 5 V
	3	INPUT VAR. LINE 1
	4	INPUT CHECK ON
	5	LOWER LIMIT 0.050 V
	6	UPPER LIMIT 4.950 V

- Item 1 Selects the channel number, 1-2, that the settings apply to. The channels correspond to specific modules and terminal blocks on the back of the LCI-100.
- Item 2 Selects the input range for the channel in Item 1. The choices are 4-20 mA, 0-5V, 0-10V and $\pm 5V$.
- Item 3 Assigns the analog input channel to a line variable. The choices for the standard LCI-100 are LINE 1, LINE 2 or NONE. These are fixed selections. When item 1 channel number 1 is selected the only choices in this field are either LINE 1 or NONE. LINE 1 input can not be placed on analog input 2 only analog input 1. Items 4-7 are disabled when NONE is selected. Also when NONE is selected the displayed is forced to zero.
- Item 4 Selects whether input from this channel is monitored for out-of-range values or not. This is a unique feature of the LCI-100 – see Section 6.3.2 for details.
- Item 5 Selects the lower limit for sensor input, below which an "input check" error will occur. See Section 6.3.1 for details.
- Item 6 Selects the upper limit for sensor input, above which an "input check" error will occur. See Section 6.3.1 for details.

6.3.1 Sensor Input Check Alarm

Sensor input checking is a unique feature of the LCI-100, which is particularly important for multiple input configurations, but can be useful for single input operation as well.

When input checking is turned **ON** (as shown in the sample menu above), input values less than the Lower Limit (item 6, shown as 0.050 V) or greater than the Upper Limit (item 7, shown as 4.950 V) will automatically switch from the normal **RUN** screen to the **DIAG** screen, with the offending channel(s) displayed in reverse video. At the same time the alarm attached to OPTO1 \pm will be turned on. (It can be turned off in the usual way by pressing the **ALRM** button.)

Input checking allows faulty load cells in a multiple-cell configuration to be instantly identified – something that is not possible with summing boxes. This feature also provides an independent check for over-range conditions, even when an appropriate TENSION alarm has *not* been set up. This double-level of monitoring, if properly configured, can provide enhanced operator safety.

6.4 Analog Output Channels

The analog output hardware is configured through the **5.2 ANALOG OUTPUT CONFIG** menu, shown below. The purpose of the analog output channels is to create a signal that mirrors one of the line variables over a user determined range. Additional hardware modifications are necessary to switch between these outputs. A description of each item in this menu is given below:

5.2 ANALOG OUTPUT CONFIG		
> 1	CHANNEL NO.	1
2	OUTPUT RANGE	0 – 5 V
3	INPUT VAR.	LINE 1
4	FULL SCALE	6000 LBS
5	OFFSET	3000 LBS

Item 1 Selects the channel number, 1-2, that the configuration applies to. These channels correspond specific terminal blocks on the back of the LCI-100 as shown below:

Channel	No Module Used	Module Used
AOUT – 1	ANALOG – AOUT0/COM	ANALOG - MOD3: CH3HI/LO
AOUT – 2	ANALOG – AOUT1/COM	ANALOG - MOD4: CH4HI/LO
AOUT – 3	N/A	ANALOG - MOD5: CH5HI/LO
AOUT – 4	N/A	ANALOG - MOD6: CH6HI/LO

Figure 6.1 – Analog Output Module Locations and Menu Names

- Item 2 Selects the analog range for the channel in Item 1. The choices are 4-20 mA, 0-5 V, 0-10V and –10 to +10V. The appropriate range is determined by the output module installed and the hardware jumper configurations; the menu should be set to match the installed module range.
- Item 3 Assigns the analog output to a given line variable. The choices are **NONE**, **LINE 1** or **LINE 2**. If **NONE** is selected, items 4 and 5 are disabled.
- Item 4 Sets the analog output full scale value (see Section 6.4.1).
- Item 5 Sets the analog output offset (see Section 6.4.1).

6.4.1 Calibrating the analog output signal

Items 4 and 5 in the **5.2 ANALOG OUTPUT CONFIG** menu allow the analog output for a given line variable to be scaled in any way the user desires. Item 5 specifies the "offset", which is the value of the variable that corresponds to the lower limit of the output range – for example, the value that produces 4 mA or 0 V. Line values below the "offset" usually produce the same (minimum) output (some 4-20 modules can generate currents less than 4.00 mA). Similarly, item 4 specifies the value of the line variable that corresponds to the upper limit of the output range, i.e. 20 mA or 5 V, etc. Line values above the "full scale" value generate the same (maximum) output. This flexible arrangement allows the LCI-100 to meet the requirements of almost any conceivable data system or output device.

6.5 Alarm Configuration

The **5.3 ALARM CONFIGURATION** menu is distinct from the **1.0 SET ALARMS** menu, which was described in §5.3.2. **Set Alarms** allows one to conveniently change the *value* of a 'trip point', while **Alarm Configuration** allows the user to disable the alarm completely, change the variable associated with the alarm, or change the alarm from a "High" (value above) to a

"Low" (value below) condition. Menu **4.3** described below can be reached either through Item 7 of the **1.0 SET ALARMS** menu, or Item 5 of the **5.0 SYSTEM CONFIGURATION** menu.

4.3 ALARM CONFIGURATION		
> 1	ALARM NO.	3
2	VARIABLE	LINE 2
3	OUTPUT TO	SCR+OP2
4	ALARM TYPE	HIGH
5	LIMIT	1000 TONS
6	DEADBAND	20 TONS

- Item 1 Selects one of the six available alarm settings. Each alarm, when activated, displays a message on the RUN SCREEN that remains until the alarm condition disappears, and optionally turns on one of the four Output modules, which can be used to signal a remote data system, flash a light or sound an alarm.
- Item 2 Selects the line variable to be monitored. The choices are **NONE**, **LINE 1** and **LINE 2**. A setting of **NONE** disables the remaining items.
- Item 3 Specifies what happens when the alarm is activated. See Section 6.5.3 for details.
- Item 4 Specifies whether the alarm is turned on when the value is above the limit (**HIGH**) or below the limit (**LOW**). See Section 6.5.1.
- Item 5 Sets the limit above or below which the alarm occurs. If the variable is assigned to the top display, this value also appears as a 'tick mark' on the bar graph. The limit is compared *algebraically* with the line variable, thus a tension of **-10 LBS** is *above* a limit of **-11 LBS**. Tick marks are shown at absolute value positions.
- Item 6 Specifies how much the value must change before the alarm is turned *off*; alarms always turn *on* at the specified limit. In the menu above, Alarm #3 will turn on when Line 2 exceeds 1000 tons, remaining on until Line 2 falls below 980 tons.

6.5.1 Alarm types

Alarms are tripped when the line variable is either on the "high side" (above the limit), or on the "low side" (below the limit). High limits are indicated by a ">" ("greater than") symbol in the **1.0 SET ALARMS** menu (§5.3.2) and by an "H" following the variable name in the alarm message. Low limits are indicated by a "<" ("less than") symbol in menu 1.0, and by the letter "L" in the alarm message.

6.5.2 Alarm limits

There are no restrictions on the value entered as the limit; the comparison is made algebraically with the line variable, thus a High Limit of **"-1000"** will cause an alarm if the variable goes to **"-900"**. Few applications use negative limits, hence "high" usually means a value whose magnitude is larger than the limit.

6.5.3 Alarm outputs

When an alarm condition occurs, the thing that *always* happens is that a message appears on the RUN screen. This message stays there until the condition goes away, i.e. the value changes by more than the specified deadband (in the correct direction).

Alarm conditions can also be used to turn on a warning light, create a raucous sound, or signal a remote monitoring system. These actions are accomplished by turning on one of the optional “Opto Modules”, which can then be wired to set off an external alarm. Since the LCI-100 can have up to eight (8) such modules, the possible output options (Item 3) are: **SCREEN, SCR+OP1, SCR+OP2, ... SCR+OP8**. More than one alarm can be assigned to the same module, but keep in mind that Input Check errors (§6.3.2) always turn on OPTO1 and the Shunt Cal feature (§5.8, §5.9) always uses OPTO8.

Since external alarms are both useful *and* annoying, the LCI-100 provides a simple way to turn off the buzzer while still reminding the user of the alarm condition. A single press of the **ALRM** button will turn off all Opto Modules, but the screen display will remain until the condition goes away. Note that if the variable falls below the limit, but then exceeds it again, the external alarm will come on again. Pressing the **ALRM** button does not disable future alarms, it only resets current ones.

6.6 Serial Communication

The LCI-100 has two serial ports: the NETWORK port is dedicated to supporting remote displays, using the RS-232 or RS-485 protocol, while the other (the AUXiliary Port), is available for transmitting data to remote processing facilities, using the RS232 protocol at 4800-19200 baud, in either a broadcast or polled mode. The AUX port supports several customized data streams, allowing the LCI-100 to be retrofit into existing applications. The **5.4 SERIAL CONFIGURATION** menu controls how the LCI-100 uses its serial ports.

Here is a typical menu display:

5.4 SERIAL CONFIGURATION		
>	1	LOC/REMOTE LOCAL
	2	CONFIG REMs NO
	3	
	4	AUX COM PORT ON
	5	BAUD RATE 9600
	6	PROTOCOL # 1
	7	XMIT MODE POLLED

- Item 1 Selects **LOCAL**, **REM-A** or **REM-B** modes of operation. **REM-A** and **REM-B** modes turn the LCI-100 into a remote display, receiving data through the network communication port, rather than field sensors. See Section 7.0 for details.
- Item 2 This item only appears when units are set to **LOCAL** mode. Selecting this item, changing it to **YES**, and pressing **RUN** downloads the entire set of configuration parameters to all REM-B units attached to the Network port.
- Item 3 This item is reserved for future use; it is skipped when moving the cursor.
- Item 4 Turns the AUX port **ON** or **OFF**. When set to **OFF**, items 5-7 are disabled. If the AUX port is not connected to another system it is prudent to set this item to OFF.
- Item 5 Selects the baud rate (4800, 9600 or 19200) used by the AUX port. The character format is “N81”, i.e. no parity, 8 data bits and 1 stop bit.
- Item 6 Selects the data protocol used by the AUX port. There are currently four options: '0', '1', '2', '3', which are discussed in Section 6.6.4 below.

- Item 7 Selects whether output from the AUX port is "broadcast" or "polled". The details are spelled out in Section 6.6.5.

6.6.1 Local/Remote operation modes

The basic LCI-100 is a self-contained instrument, which both measures and displays the two standard line variables: Line 1 and Line 2. When operating in this manner the instrument is said to be in **LOCAL** mode. All features of the instrument are available in this mode, including the ability to behave as a Remote (update via the network communication port) device.

REM-A mode (also known as an "Active Remote") retains use of the normal set of buttons for customizing the display. An "Active Remote" can be configured to mimic the LOCAL display, or can be programmed for a more flexible application. For example, the local display can interface with sensors and be located near the physical location of the winch. A second LCI-100 can be configured through the menu as a **REM-A**, and can output serial communications to nearby data loggers, or can have its own alarm outputs, operating independently from the LOCAL unit. The position and precision of the variables on the screen can be set for the preferences of a different viewer. When a LCI-100 is set as **REM-A**, it will not accept configuration information from a LOCAL display; it is only configured from the keypad and menu.

REM-B displays (also called "Blind Remotes") mimic the operating mode of the LCI-90R, which has no buttons and can only be configured from a LOCAL unit. The **REM-B** models have no sensor input or output capability. When a display is configured as a **REM-B**, it will receive its configuration information from the LOCAL.

6.6.2 Programming remote displays

In addition to the steady stream of Line 1 and Line 2 data from the Local unit, Remote displays configured as REM-B also recognize specially-formatted configuration data. When such data is detected, the Remote display immediately updates its operation, including screen displays and alarm limits to match that of the Local unit (with the exception that it remains a Remote!). This facility allows a group of LCI-100s to be quickly programmed with the same configuration parameters – even if they are subsequently used as "Locals" in independent systems.

To perform a "remote configuration", simply connect one or more Remote units to a Local using the Network Port. Ensure that all remote displays to be programmed are set to **REM-B** in the **5.4 SERIAL CONFIGURATION** menu. After all units are powered up and seem to be working properly, select the **CONFIG REM** menu item, change it to **YES** (it always defaults to **NO**) and press **RUN**. All displays should "freeze" for a few seconds, then resume operation with the new set of parameters.

It is possible that a very noisy network connection (this *does* happen!) could corrupt the data. If the Remote unit detects any errors, and is unable to obtain an error-free set of parameters after several attempts, it will revert to its existing values and display the message: **SU-ERR** in the top display position ("SU" stands for "SetUp"). Should this happen, the best approach is simply to repeat the operation; if difficulties persist, then general operation of the unit as a Remote is questionable and the connection should be monitored with a suitable receiver.

6.6.3 AUX com port settings

Note that both Remote as well as Local units can use the AUX port to send data to other systems (a ship board computer, for example). A network with one local LCI-100 and two Remote LCI-90Rs could thus be attached to three separate data logging systems, each using a different protocol.

The AUXiliary serial port is designed for communicating with other user devices, including remote data-logging or monitoring systems. It uses the familiar RS232 protocol, sending each character in a "N81" format (no parity, 8 data bits, 1 stop bit). The baud rate is selected by Item 5: the choices are 4800, 9600 or 19200 (contact the factory if other values are required). If no devices are attached to this port, selecting **OFF** will improve the performance of the instrument, since it prevents spurious electrical noise from interrupting the display.

If a serial device (anything from a PC running a terminal-emulator program, such as HyperTerm to a more elaborate data logging/display system) is attached to the AUX port, then the remaining items in this menu become important. Beyond the obvious baud-rate selection, the most important parameter is the protocol selection, which is discussed in the following section.

6.6.4 Protocol descriptions

The data transmitted through the AUX port contains (usually) values Line 1 and Line 2 (sometimes known by other names). The format of this data is determined by the "protocol" selected. The LCI-100 currently supports four protocols, numbered: 0, 1, 2, 3. Protocol '0' is a special 'diagnostic' protocol that is normally only used during production.

Protocol '1' is the LCI-100's Remote Data protocol. This format is the same one used to send data to Remote Displays over the network communications port; it is a check-summed, comma-separated, maximum precision, zero-filled format, consisting of strings with the form:

```
"RD,-LLLLL.LL,-TTTTT.TT,CCCC<CR><LF>"
```

where "RD" identifies the record as a Remote Data string, "-" stands for an optional minus sign, which is always the first character (but omitted if the data is positive). "LLL" is the Line 1, "TTT" is the Line 2. Each field is 8 characters long, with leading 0's as needed. The indicated decimal points are only symbolic – integer values will not have a decimal point, and the number of digits following the decimal point (if any) is adjusted on a record-by-record basis to reflect the internal accuracy of the data.

Programs written to parse these strings should look for the commas. (Excel calls this a 'CSV', Comma Separated Values, format). "CCCC" is a 4-digit (always!) decimal field, which contains the sum of the ASCII values of all preceding characters, including the commas (but not including the four CCCC characters). All characters included in the sum have ASCII values less than 127, hence it will not matter if the receiving device uses "7-bit" or "8-bit" characters. Spurious characters preceding "RD" may occur, and should be ignored. Each record ends with a Carriage Return (ASCII 13) + Line Feed (ASCII 10), which are not included in the checksum.

Protocols '2' and '3' consist of strings with the general form:

```
"xx00_LLLLLLL_0_TTTTTTT_0<CR><LF>"
```

where "LLL", "TTT" are 7-character (including sign and decimal point) strings for the LINE 1 and LINE 2 values. The number of decimal places is determined by the configuration setting for the respective displays (see §5.10.3). Minus signs (if any) appear just before the first significant digit, with the remainder of the field filled with spaces (ASCII 32). The first two characters, "xx", are "***" (two stars) for Protocol #2, and "<CR><LF>" (Carriage Return, Line Feed) for Protocol #3. This is followed by "00"

(two 'zeros'), then either a SPACE (Protocol #2) or a COMMA (Protocol #3), seven characters for the LINE 1, a SPACE or COMMA (represented by "_"), then a "0" (zero), and so on for LINE 2. The string ends with a Carriage Return (ASCII 13) and Line Feed (ASCII 10).

Additional, or alternative, protocols can be supported. Contact Measurement Technology NW for advice on this matter.

6.6.5 Polling Strings

Item 7 controls whether the AUX port transmits data continuously ("BRDCAST" mode), or only after the LCI-100 has received a specified "Polling String" ("POLLED" mode). Polled mode is generally the preferred method of operation, since it allows the remote device to control the data flow, and thus to receive data only when it is ready for it. Each protocol has its own designated Polling String. For Protocols '0' and '1' (the two MTNW protocols), the Polling String can be anything containing a Carriage Return (ASCII 13). Thus if the AUX port is connected to a "Terminal Emulator" program running on a PC (for example "HyperTerm"), just hitting the Enter key will cause the LCI-100 to send a data string. Similarly, a data-logging system only needs to send a "blank line" to get a response.

Protocols 2 and 3, on the other hand, requires a specific string, "SS", followed by a Carriage Return (+ optional Line Feed). Sending a blank line, or even a line containing "ss" (i.e. lower case letters) will not produce any output.

7.0 Remote Display Operation

For applications where data from a local LCI-100 needs to be displayed at another physical location, there are two solutions available: use a second LCI-100, or use the LCI-90R dedicated remote display.

A LCI-100 Local display can be configured to behave as a remote display in two different ways. (1) **REM-A**, or Active mode, described in Section 7.1, allows the operator to set up the display through the menu. (2) **REM-B**, or Blind mode, described in Section 7.2, only allows configuration changes via ‘downloading’ from a Local unit, as described in §6.6.2. In either mode the LCI-100 retains the ability to generate digital (alarm) and analog output.

Also operating in REM-B mode, the LCI-90R is a lower-cost, dedicated-function remote display, which only accepts data from a LCI-100 via the network communications port and has no provision for analog or digital output.

Remote displays receive their data from the network port. The data is sent using a flexible, check-summed protocol (described in Section 6.6.4), which maintains the full accuracy of the instrument. Although the data used by a Remote unit comes from a Local, the display format is completely independent. REM-A (Active) Remotes (those with buttons) can be configured from the front panel, while REM-B (Blind or LCI-90R) Remotes can only be configured from a Local (or by the Supplier).

Remote displays depend on a steady stream of data from the Local unit, hence if that stream is interrupted for more than five (5) seconds, (for example the Local unit is powered down, or the Network is disconnected), then the Remote will blank all display fields to prevent the user from being misled by "stale" values. The bar-graph, on the other hand, remains "frozen" at its last value, serving as a further clue that something is amiss. In addition, REM-B units change the text at the bottom of the screen from "**REMOTE DISPLAY**" to "**REMOTE DISPLAY NO VALID DATA**".

7.1 Active Remotes – REM-A

Active Remote displays (REM-A) are ideal for monitoring applications in which the user wishes to configure the display (including the Alarm settings) in a manner that differs from the Local unit. Setting up a REM-A display is completely straight-forward: simply use the Keypad keys as described for the Local LCI-100, but be sure to set Item 1 of the **5.4 SERIAL CONFIGURATION** menu to **REM-A**.

Connect the Network Ports of the Local and Remote (be sure to use the correct polarity!), and the Remote unit’s display should immediately “come to life”. If the Remote does not receive valid data within a 5-second time period, it will blank the display as described above. If this should happen, first check the Network connection, then check that the unit is actually set for REM-A operation.

Finally, while the main advantage of a REM-A display is that the user can control the “look and feel”, such displays can also be quickly configured to look exactly like the Local simply by setting Item 1 of the **5.4 SERIAL CONFIGURATION** menu to **REM-B** and using the **5.4.2 CONFIG REMs** menu item (which is only available on a Local unit). See §6.6.2 for details. After this operation is complete, the display can be returned to the **REM-A** mode of operation.

7.2 Blind Remotes – REM-B

Blind Remote displays (LCI-90R) have the same display and communications hardware found in the LCI-100, but lack a front panel keypad. This means that they can only be configured by connecting them to a LCI-100 Local display, or, per request, by the Supplier. REM-B units, like REM-A displays, need not use the same display configuration as other LCI-100s in the network, but in order to change a REM-B configuration, a Local unit must first be set up in the

desired manner so that its configuration can be copied to the REM-B unit by means of the **5.4.2 CONFIG REMs** menu item (which is only available on a Local unit). See Section 6.6.2 for details.

8.0 Troubleshooting

The LCI-100 was designed with the user in mind. Using full language menus and a minimum of abbreviations makes the programming and operation much easier to understand. A diagnostics screen described in the section below is easily accessible by the user to check raw input signals. Most apparent malfunctions of the instrument can usually be traced to incorrect wiring, jumper settings, or programming. Consult the troubleshooting chart in section 8.2 to diagnose apparent problems.

8.1 DIAG screen operation

Pressing the **DIAG** key from the Run mode display will bring up the Diagnostics screen. This display, shown in Figure 8.1, provides the operator with important feedback on raw signal inputs, and scaled display values for Line 1 and Line 2. From the DIAG screen, the same button, which is now labeled **MAIN**, will return the system to the main RUN display mode. The instrument continues normal operation, including updating remote displays and checking alarm limits in the background while the DIAG screen is on display.

INPUT	VALUE	SCALED
IN-1	4.765 mA	1450 LBS
IN-2	7.430 mA	2308 LBS

Figure 8.1 – Diagnostics Screen Display

The first items displayed are the active analog input channels. There can be from one to four of these, depending on the Analog Input Configuration (two are shown in Fig 8.1). These lines show the raw input signal as measured by the LCI-100, and the resulting scaled Tension *on a per-channel basis* (the combined result of multiple inputs is only displayed on the RUN screen).

The utility of the DIAG screen is clear when a malfunction occurs. Comparing the displayed values with measurements from a multimeter can help identify if the fault lies in the sensor/wiring, or within the instrument and its setup configuration.

An additional function of the DIAG screen is described in Section 6.3.2. When an Input Check Alarm occurs, the LCI-100 automatically displays the DIAG screen with the outlying input channel highlighted (as shown in Fig 8.1 for channel 1). An alarm attached to OPTO1 is also turned on. Pressing the **ALRM** button will silence the alarm and pressing **MAIN** will return to the normal RUN screen, but the channel will continue to be highlighted whenever the DIAG screen is displayed until the Input Check condition goes away.

8.2 Troubleshooting procedures

Problem	Blank Screen	
Possible Causes	Diagnosis	Remedies
Screen saver is on	Activate display by pressing any key	Disable screen saver if screen visibility is

		required during periods of inactivity
Input power problem	Check voltage between POWER IN V+ and V-. If below 18VDC then the problem is not in the display	Repair or replace power source to provide 18-36 VDC
Fuse is blown	Check voltage between POWER IN V+ and V-. If unit has power and there is no voltage, then the fuse is suspect.	Check and replace fuse
Screen is faulty	Listen closely for high frequency hum coming from the within the LCI-100	Contact supplier
Internal power supply failure	Measure voltage on the DIGITAL field terminal block bank between V+ and COM. Depending on the unit's configuration, this will either be +5 or +12 Vdc. If these voltages are out of range, the internal power supply is suspect.	Contact supplier
CPU failure	Check for communication with remote displays. If remote displays are not updating and the LCI-100 has power, then the CPU is suspect	Contact supplier

Problem No Response or Zero Value for Tension Signal on Line 1 or Line 2		
Possible Causes	Diagnosis	Remedies
Incorrect scaling	Check menu 2.1 or 3.1 for correct values of Offset and Full Scale	Recalibrate if incorrect
No sensor input	Press DIAG to view diagnostics screen. Use a multimeter to compare the raw input value with the LCI-100 displayed input	If no input signal, then replace or repair tension sensor
	Confirm that the sensor has excitation power with a multimeter. If using an external supply, ensure there are no grounding problems.	Review Section 4.1.2 for discussion of Tension input hookup.
	Check hardware jumper settings on the interface PCB to ensure that correct settings are set for the desired input range.	Review Section 4.1.2 for discussion of Tension input hookup.
	See Menu 4.2 to ensure the proper analog input channel and range are configured.	Review Section 6.3 for discussion of Analog Input Configuration.

Problem “Jumpy” Tension Signal		
Possible Causes	Diagnosis	Remedies
Electrical noise	Check input signal quality with oscilloscope. For some frequencies, a AC voltmeter can be used to measure the presence or absence of noise on a DC signal.	Use shielded cabling and/or conduit for sensor wiring
	Check that cable shields are grounded near the LCI-100 for best noise immunity.	Try variations on shield grounding. Try both ends, or no grounding.
	Baseline noise – cannot be remedied	Adjust Tension Smoothing filter to reduce the effective noise. See §5.12.4 or §5.12.8.
Ground loop	Draw or review a schematic of the tension input sensor/LCI-100 connection to identify any ground loops.	Use Isolation module on Tension input.
	Draw or review a schematic of the tension input sensor/LCI-100 connection to identify any ground loops.	Install or remove H1 to remedy ground loop problem.
Wave motions affecting	Confirm that the tension display	Adjust the Tension

tension signal	varies at the same frequency as the wave motion.	Smoothing filter. See Section §5.12.4 or §5.12.8.
----------------	--------------------------------------------------	---------------------------------------------------

Problem Run Screen Visible, No Numeric Values on Screen		
Possible Causes	Diagnosis	Remedies
Incorrect menu configuration	This will occur when a unit is set to REM-A (Active Remote) and doesn't receive valid serial communication. See previous problem for diagnosis.	If unit is supposed to receive sensor input, then change the LOC/REMOTE mode to LOCAL. Otherwise see previous section.

Problem "REMOTE DISPLAY NO VALID DATA" Displayed		
Possible Causes	Diagnosis	Remedies
Incorrect menu configuration	If using the display as a local, check Menu 4.5, Item 1.	Change the Menu 4.5 Item 1 LOC/REMOTE mode to LOCAL
Incorrect serial communication wiring	Check polarity of the wiring for RS-485, with T+R+ on the local to T+R+ on the remote. For RS-232, Tx on the local should connect to Rx on the remote.	Correct any wiring errors
Incorrect serial termination	For RS-485, the display on each end of the chain should be terminated for best performance.	Check hardware jumper settings. See Appendix B

Problem No Outputs from Alarm Channels		
Possible Causes	Diagnosis	Remedies
Incorrect menu configuration	Check the alarm configuration in Menu 5.3 to make sure that the expected module will be energized by the alarm condition. Each alarm must be programmed to output to OP1-OP8 to energize a module	Review manual Section 5.3 for alarm use and configuration
Blown fuse on output module	Remove fuse and check with an ohmmeter.	Check for shorts in the circuit and replace fuse.
Incorrect module type	Verify the part number and specifications of the installed module	Replace with correct type

Problem No Shunt Calibration		
Possible Causes	Diagnosis	Remedies
Opto 8 module missing or dislodged	Open unit and look inside. Locate Opto 8 position on IFB and confirm that the Opto is there and seated properly.	Order new module or reseat
Field wire polarity not observed	DC module is polarity sensitive, requires correct field wire termination.	Check field wires and try reversing polarity
1 Amp PICO fuse blown	Locate F8 on IFB and measure resistance across fuse	Replace with correct type

8.3 Technical support

The resolution of technical problem should first be attempted using the Troubleshooting Guide in Section 8.2 or by reading the appropriate sections of the manual. If this fails, either contact the supplier from whom you purchased the display, or the manufacturer, for additional technical support. When seeking technical support, please fax or e-mail notes including a description of the problem, all relevant menu, DIP switch and jumper settings, any hardware options installed, plus a description of the field devices in use and how they are terminated on the LCI-100.

Measurement Technology Northwest
 4211 24th Ave West
 Seattle, WA 98199 USA

Ph: (206) 634-1308
 Fax: (206) 634-1308
 e-mail: lci@mtnw-usa.com

Office Hours: 8:30 AM to 5:30 PM - Pacific Time

9.0 Appendix A – Dimensional Drawing

10.0 Appendix B – Jumper Settings on Interface PCB – REV 1

Jumper	Position	Description
JP1	[1-2]	A/D Ch1 grounded
	Open*	A/D Ch1 enabled
JP2	[1-2]	A/D Ch2 grounded
	Open*	A/D Ch2 enabled
JP3	[1-2]*	A/D Ch3 grounded
	Open	A/D Ch3 enabled
JP4	[1-2]*	A/D Ch4 grounded
	Open	A/D Ch4 enabled
JP5	[1-2]*	A/D Ch5 grounded
	Open	A/D Ch5 enabled
JP6	[1-2]*	A/D Ch6 grounded
	Open	A/D Ch6 enabled
JP7	[1-2]*	A/D Ch7 grounded
	Open	A/D Ch7 enabled
JP8	[1-2]*	A/D Ch8 grounded
	Open	A/D Ch8 enabled
JP9	[1-2]*	A/D Ch3 enabled
	[2-3]	Isolated D/A Ch1 enabled
JP10	[1-2]*	A/D Ch4 enabled
	[2-3]	Isolated D/A Ch2 enabled
JP11	[1-2]	External power for 4-20mA out enabled
	Open*	Internal power for 4-20mA
JP12	[1-2]	D/A Ch1 Volt
	[2-3]	D/A CH1 mA
JP13	[1-2]	D/A CH2 Volt
	[2-3]	D/A CH2 mA
JP14	[1-2]*	Internal power select for 4-20mA
	[2-3]	External power select for 4-20mA
JP20	[1-2]*	T+/R+ RS485 serial termination
	Open	No serial termination
JP21	[1-2]*	T-/R- RS485 serial termination
	Open	No serial termination
JP22	[1-2]*	A/D Ch5 enabled
	[2-3]	Isolated D/A Ch3 enabled
JP23	[1-2]*	A/D Ch6 enabled
	[2-3]	Isolated D/A Ch4 enabled
HDR1	[1-2]	High
	[2-3]	Low
	Open*	High
HDR2	[1-2]	High
	[2-3]	Low
	Open*	High
HDR3	[1-2]	High
	[2-3]	Low

	Open*	High
HDR4	[1-2]	High
	[2-3]	Low
	Open*	High

* Denotes factory default settings

LCI-90R Display Scan Rate (HT Option Only)

Display Luminance	SW2-1	SW2-2
100%	OFF*	OFF*
75%	OFF	ON
50%	ON	OFF
30%	ON	ON

* Denotes factory default settings

11.0 Appendix C – Analog Hardware Configuration

Non-isolated Analog Input (0-5VDC):

Sensor Input	Jumper Settings	Hardware Modifications
Channel 1	JP1 Open	Signal wires installed to defeat isolation barrier
Channel 2	JP2 Open,	Signal wires installed to defeat isolation barrier
Channel 3	JP3 Open, JP9(1-2)	Signal wires installed to defeat isolation barrier
Channel 4	JP4 Open, JP10(1-2)	Signal wires installed to defeat isolation barrier
Channel 5	JP5 Open, JP22(1-2)	Signal wires installed to defeat isolation barrier
Channel 6	JP6 Open, JP23(1-2)	Signal wires installed to defeat isolation barrier

Non-isolated Analog Input (4-20mA):

Sensor Input	Jumper Settings	Hardware Modifications
Channel 1	JP1 Open	Signal wires installed to defeat isolation barrier, 250 Ohm resistor installed at R1
Channel 2	JP2 Open,	Signal wires installed to defeat isolation barrier, 250 Ohm resistor installed at R2
Channel 3	JP3 Open, JP9(1-2)	Signal wires installed to defeat isolation barrier, 250 Ohm resistor installed at R3
Channel 4	JP4 Open, JP10(1-2)	Signal wires installed to defeat isolation barrier, 250 Ohm resistor installed at R4
Channel 5	JP5 Open, JP22(1-2)	Signal wires installed to defeat isolation barrier, 250 Ohm resistor installed at R5
Channel 6	JP6 Open, JP23(1-2)	Signal wires installed to defeat isolation barrier, 250 Ohm resistor installed at R6

Isolated Analog Input:

Channel	Jumper Settings	Hardware Modifications
1	JP1 Open	Correct module installed
2	JP2 Open	Correct module installed
3	JP3 Open, JP9(1-2)	Correct module installed
4	JP4 Open, JP10(1-2)	Correct module installed
5	JP5 Open, JP22(1-2)	Correct module installed
6	JP6 Open, JP23(1-2)	Correct module installed

Non-isolated Analog Output (0-10VDC):

Output Channel	Jumper Settings	Hardware Modifications
AOUT 1	JP12(1-2)	None
AOUT 2	JP13(1-2)	None

Non-isolated Analog Output (4-20mA) Internal Excitation:

Output Channel	Jumper Settings	Hardware Modifications
AOUT 1	JP12(1-2), JP14(1-2), JP11(OFF)	None
AOUT 2	JP13(1-2), JP14(1-2), JP11(OFF)	None

Non-isolated Analog Output (4-20mA) External Excitation:

Output Channel	Jumper Settings	Hardware Modifications
AOUT 1	JP12(1-2), JP14(2-3), JP11(ON)	None
AOUT 2	JP13(1-2), JP14(2-3), JP11(ON)	None

Isolated Analog Output:

Channel	Jumper Settings	Hardware Modifications
1	JP3 Open, JP9(2-3)	Correct module installed
2	JP4 Open, JP10(2-3)	Correct module installed
3	JP5 Open, JP22(2-3)	Correct module installed
4	JP6 Open, JP23(2-3)	Correct module installed

12.0 Appendix D – Interface PCB REV 1

13.0 Appendix E – Wrap Angle Calculations

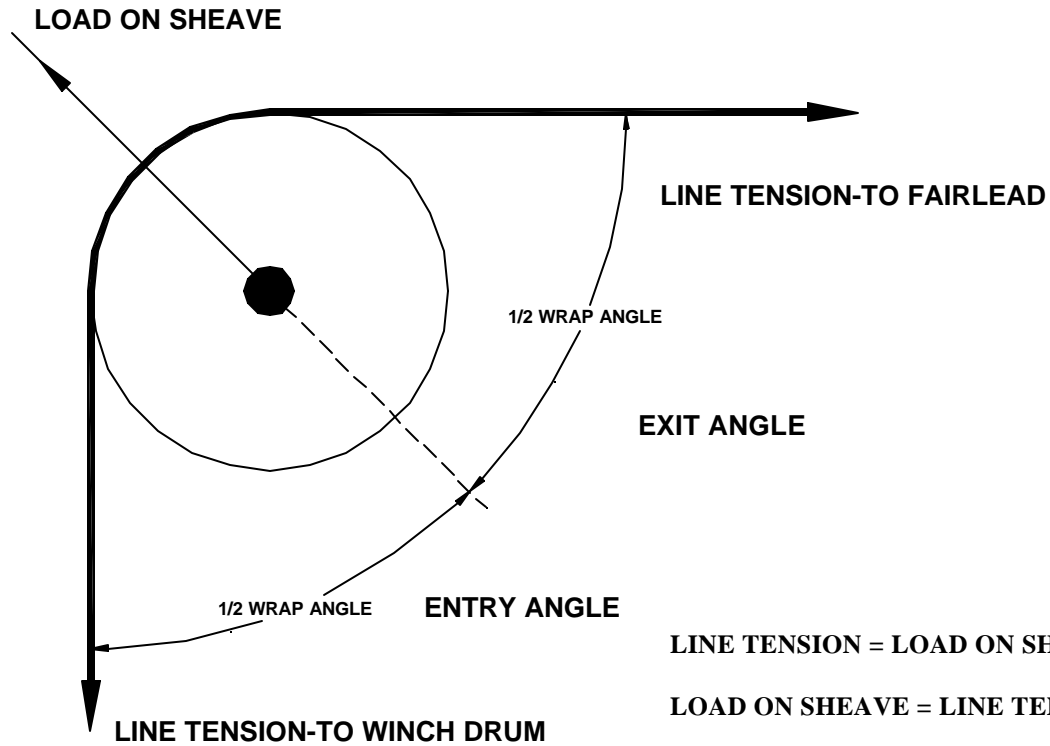

Wrap Angle Correction Factor (WACF)

Angle	WACF	Angle	WACF	Angle	WACF	Angle	WACF	Angle	WACF
0	1.0000*	38	0.52881	76	0.63451	114	0.91804	152	2.06678
2	0.50080	40	0.53209	78	0.64338	116	0.94354	154	2.22271
4	0.50030	42	0.53557	80	0.65270	118	0.97080	156	2.40487
6	0.50069	44	0.53927	82	0.66251	120	1.00000	158	2.62042
8	0.50122	46	0.54318	84	0.67282	122	1.01539	160	2.87939
10	0.50191	48	0.54732	86	0.68366	124	1.06503	162	3.19623
12	0.50275	50	0.55169	88	0.69508	126	1.10134	164	3.59265
14	0.50375	52	0.55630	90	0.70711	128	1.14059	166	4.10275
16	0.50491	54	0.56116	92	0.71978	130	1.18310	168	4.78339
18	0.50623	56	0.56629	94	0.73314	132	1.22930	170	5.73686
20	0.50771	58	0.57168	96	0.74724	134	1.27965	172	7.16779
22	0.50936	60	0.57735	98	0.76213	136	1.33473	174	9.55366
24	0.51117	62	0.58332	100	0.77786	138	1.39521	175	11.46279
26	0.51315	64	0.58959	102	0.79451	140	1.46190		
28	0.51531	66	0.59618	104	0.81213	142	1.53578		
30	0.51764	68	0.60311	106	0.83082	144	1.61803		
32	0.52015	70	0.61039	108	0.85065	146	1.71015		
34	0.52285	72	0.61803	110	0.87172	148	1.81398		
36	0.52573	74	0.62607	112	0.89415	150	1.93185		

- A Wrap Angle of '0' is treated as a special case, giving a factor of '1' rather than ½

14.0 Appendix F – LCI-100 Specifications

LCI-100	PHYSICAL/POWER	Std/Option
Temp.	-20°C to 60°C	Std
	-40°C to 70°C	HT
Environmental	NEMA 4X front panel	Std
	NEMA 1 rear enclosure	Std
Dimensions	10.0" wide x 8.0" high x 5.5" deep	Std
	Cut out: 9.25" wide x 7.00" high	Std
Weight	7.0 pounds	Std
Materials	Stainless Steel 316 front panel	Std
	Polycarbonate display window	Std
	Urethane front panel gasket	Std
Power	18-36 VDC, 0.5 A typical, 0.75 A maximum	Std
Heat Output	8 Watts typical	Std

LCI-100	DISPLAY	Std/Option
Type	Graphic electro-luminescent, 320 x 240 pixels	Std
View Angle	160 degrees	Std
Viewing Area	4.7" wide x 3.6" high	Std
Brightness	High brightness – 50 cd/m ²	Std
	Ultra high brightness – 340 cd/m ²	HT
Contrast	Fixed	Std
	Adjustable	HT
Characters	6 at top center, 4 at lower left, 5 at lower right	Std

LCI-100	DIGITAL I/O – ALARMS	Std/Option
Channels	Eight total, input and output, menu configurable	Std
Type	TTL	Std
	Fused output module: dry contact, 1.0 A max, 3-60 VDC	01
	Fused output module: solid state, 1.0 A max, 3-60 VDC	02
	Fused input module: 3-32 VDC	03
	Fused input module: 90 to 140 VAC	04

LCI-100	SERIAL COMMUNICATION	Std/Option
Type	Network Port, RS-232, non-isolated	10
	Network Port, RS-485, 2 wire, isolated	11

	Auxiliary Port, RS-232, non-isolated	12
Baud Rate	Network Port 19200, Aux Port 4800 to 19200	Std
Protection	RS-485 option, 2500 V rms	11

LCI-100	ANALOG SENSOR INPUT	Std/Option
Type	4 to 20 mA, non-isolated, 2,3 and 4 wire	Std
	0-5 VDC, non-isolated	Std
	0-10 VDC, non-isolated	20
	4 to 20 mA, isolated, 2, 3 and 4 wire	21
	0-10 VDC, isolated	22
	4 Wire Strain Gauge, load range 10 k Ω to 300 Ω	23
Channels	Six channels total (standard firmware can use five)	Std
Protection	16 V peak DC	Std, 20
	1500 V rms	21 – 23
Impedance	Non isolated 4 to 20 mA input: 250 V	Std
	Non isolated VDC input: 100,000 Ω	Std
Resolution	12 bits (1/4096)	Std
Accuracy	Base unit: 0.05%	Std
	Optional isolated input modules: 0.05%-0.08%	21 – 23
Scan Rate	1.5 Hz (typical) with 10 times over-sampling	Std
Excitation	12 VDC, 250 mA (total for device)	Std
	5 VDC, 250 mA (total for device)	Std
	24 VDC, 1.0 A (total for device)	43

LCI-100	ANALOG OUTPUT	Std/Option
Type	4 to 20 mA, non-isolated, 15 VDC maximum	30
	0-10 VDC, non-isolated, load range 0 to 1000 Ω	31
	4 to 20 mA, isolated, load range 0 to 750 Ω	32
	0-10 VDC, isolated, load range 0 to 1000 Ω	33
Channels	Four channels total	30 – 31
Protection	Non-isolated, 16 V peak DC	30, 31
	Isolated, 4 to 20 mA, 240 V rms	32, 33
Resolution	12 bits (1/4096)	Std
Accuracy	0.05% (\pm 1 LSB)	Std
Update	4 Hz (typical)	Std

15.0 Appendix G – LCI-90R Specifications

LCI-90R	PHYSICAL/POWER	Std/Option
Temp.	-20°C to 60°C	Std
	-40°C to 75°C	HT
Environmental	NEMA 4X front panel	Std
	NEMA 1 rear enclosure	Std
Dimensions	7.6" wide x 5.7" high x 4.0" deep	Std
	Cut out: 7.15" wide x 5.25 high	Std
Weight	3.4 pounds	Std
Materials	Stainless Steel 315 front panel	Std
	Polycarbonate display window	Std
	Urethane front panel gasket	Std
Power	18-36 VDC, 0.5 A typical, 0.75 A maximum	Std
	85-265 VAC, 13 W typical, 18 W maximum	AC
Heat Output	8 Watts typical	Std

LCI-90R	DISPLAY	Std/Option
Type	Graphic electro-luminescent, 320 x 240 pixels	Std
View Angle	160 degrees	Std
Viewing Area	4.7" wide x 3.6" high	Std
Brightness	High brightness – 50 cd/m2	Std
	Ultra high brightness – 340 cd/m2	HT
Contrast	Fixed	Std
	Adjustable	HT
Characters	8 at top center, 4 at lower left, 5 at lower right	Std

LCI-90R	SERIAL COMMUNICATION	Std/Option
Type	Network Port, RS-232, non-isolated	Std
	Network Port, RS-485, 2 wire, isolated	11
	Auxiliary Port, RS-232, non-isolated	12
Baud Rate	4800 to 19200	Std
Protection	RS-485 option, 2500 V rms	11